

CONTENTS

- **Safety Precautions: Observe at All Times** 6
 - General Diving Precautions - 8
 - Precautions Relating to Use of this Watch - ... 9
- **Introduction** 13
- **Expose the Watch to Light Before Using** ... 14
- **Features** 15
- **Names of Components** 18
 - [Digital Display] 19
- **Charge Level Indicator and Continuous Operating Times** 20
 - 1. Reading the Charge Level Indicator 21
 - 2. General Reference for Charging Times 22
 - 3. Continuous Operating Time 22
- **Unique Functions of Solar-Powered Watches** 24
 - [Insufficient Charge Warning Function] 26
 - [Overcharge Prevention Function] 26
 - [Power Save 1 Function] 27
 - [Power Save 2 Function] 28
- **Watch Display Modes (Functions)** 29
 - [Standard Mode] 29
 - 1. Time/Date Mode 29
 - 2. Surface Mode 29
 - 3. Travel Time Mode 29
 - 4. Alarm 1, 2 and 3 Modes 29
 - 5. Dive Alarm Setting Mode 29
 - 6. Diving Log Recall Mode 29
 - 7. Reference Position Check Mode 29

- [Diving Mode] 30
 - 1. Diving Ready 1 Status 30
 - 2. Diving Ready 2 Status 30
 - 3. Water Depth Measurement Status 31
 - 4. When Having Returned to a Shallow Depth of within 1 m (4 ft) After Diving 31
- **Switching the Mode** 32
- **Using the Standard Mode** 34
 - 1. Using the Time/Date Mode 34
 - A. Setting the Time and Date 34
 - 2. Using the Surface Mode 37
 - 3. Using the Travel Time Mode 39
 - A. Setting Travel Time 39
 - B. Switching Between Travel Time and Time/Date Modes 41
 - 4. Using the Alarm Mode 43
 - A. Setting the Alarm 44
- **Displayed Cities** 46
- **Precautions During Diving** 48
 - Using the Watch when Diving 48
 - Prohibited Matters When Using During Diving ... 50
 - Precautions Before Diving 51
 - Precautions During Diving 52
 - Precautions After Diving 53
- **Diving Terms** 54
 - 1. Diving 54
 - 2. Measurement of Water Depth 55
 - 3. Measurement of Dive Time 56
 - 4. Measurement of Water Temperature 57
 - 5. Recording of Log Data 57
 - 6. Termination of the Diving Mode 57
- **Dive Alarm Functions** 58
 - 1. Main Types of Dive Alarms and Situations in which Main Dive Alarm Function are Activated ... 59

2. Explanation of Dive Alarm Functions	60	■ Using the Diving Log Recall Mode	75
<Digital Display Error>	60	A. Log Data Display Range	76
When a Digital Display Error Occurs While		B. Recalling Log Data	77
Diving:	61	C. Log Number	78
<Water Sensor Error>	62	D. Deleting Log Data	78
<Pressure Sensor Error>	62	E. Regarding Log Data	79
When a Pressure Sensor Error Occurs While		■ Reference Position Check Mode	80
Diving:	62	A. Checking the Reference Position	80
<Measurement Error (0 m/0 ft Detection)>	63	■ Troubleshooting	82
[Canceling Abnormal Measured Value]	63	■ Meanings of Frequently Displayed Mode	
<Diving Log Memory Error>	64	Marks and Digital Display	86
<Charge Alarm>	65	[Mode Marks]	86
When Low Charge is Displayed during		[Digital Display]	87
Diving:	65	■ All-Reset	90
When the Insufficient Charge Alarm is		[Procedure]	90
Displayed While Diving:	66	■ Using EL light	92
<Depth Measurement Error>	67	■ Models Provided with an Extension Band	92
<Depth Measurement Out of Range Alarm>	67	■ Handling Precautions (for the watch)	93
[Canceling Depth Measurement Out of		Water Resistance Performance	93
Range Alarm]	67	Handling of Energy Storage Cell	94
<Ascent Rate Alarm>	68	Only Use Specified Energy Storage Cell	95
[Canceling the Ascent Rate Alarm]	68	Repairs	95
<Depth Alarm>	68	Keep your watch clean	95
[Canceling the Depth Alarm]	68	<Cleaning the Watch>	96
<Dive Time Alarm>	68	Precautions When Wearing the Watch	96
■ Using the Diving Mode	69	Handling of the Band (Cautions when Putting	
1. Using the Dive Alarm Setting Mode	69	on and Taking Off the Watch)	96
A. Normal Display in Dive Alarm Setting Mode	69	<Temperatures>	96
B. Setting Dive Alarms	70	<Static Electricity>	97
2. Switching to the Diving Mode	72	<Shocks>	97
[When the Watch is Switched to the Diving		<Chemical Agents, Gases and Mercury>	97
Mode]	72	<Storage>	97
[The display changes in the following		■ Specifications	98
manner according to dive status]	73		

Safety Precautions: Observe at All Times

The following provides an explanation of those matters that should be observed at all times to prevent injury to the wearer or other persons as well as damage to property before they occur.

- The degree of injury or damage resulting from incorrect use while ignoring the indicated matters is classified and explained using the following markings.

DANGER

This marking indicates matters for which there is a high risk of death or serious injury.

WARNING

This marking indicates matters for which there is the risk of death or serious injury.

CAUTION

This marking indicates matters for which there is the risk of minor injury or property damage.

- The types of matters to be observed are classified and explained using the following mark (the following indicates two examples of icons).

 This mark indicates that caution or attention is required.

 This mark indicates prohibited matters.

DANGER

Please read this user's manual carefully to make sure you have a thorough understanding of the handling and operating procedures, displays and limitations of this watch and ensure its proper use. Improper use of this watch or failure to observe displayed warnings, cautions and instructions can result in the risk of a fatal or serious accident.

CAUTION

Diving is a potentially dangerous sport. When using this watch for diving, make sure you have a proper understanding of the procedures for handling the watch as described in this manual and observe proper procedures. Handling of this watch in a manner contrary to that described in this user's manual may prevent the watch from functioning properly.

Request to Customers

All repairs performed on this watch, excluding repairs involving the band, are to be performed at the CITIZEN. When desiring to have your watch repaired or inspected, please contact the Citizen Service Center either directly or through the store where you purchased your watch.

- General Diving Precautions -

WARNING

- **In the case of using this watch for diving, always make sure to receiving the proper diving training from a licensed instructor to acquire the experience and skills required for safe diving.**
- **Make sure you have completely mastered the handling and operation of this watch.** Even recreational diving can be potentially dangerous. Diving without the proper or adequate training can lead to a fatal or serious accident.

WARNING

Each diver should take responsibility for planning and executing his or her own diving plan to ensure safe diving. This watch is not equipped with a function that prevents decompression sickness. In addition, this watch is also unable to check differences in physiological functions of individual divers or differences in physical condition on that day. Since the occurrence of decompression sickness is greatly affected by physical condition, the degree of the risk of decompression sickness varies depending on your physical condition on that day. It is recommended to avoid diving whenever you are in poor physical condition such as when you are ill, fatigued, have not had enough sleep or have a hangover.

- Precautions Relating to Use of this Watch -

DANGER

- **This watch is not equipped with a function that indicates decompression diving.** Do not engage in decompression diving while using this watch.
- **This watch is not compatible with Nitrox diving.** Never use this watch for Nitrox diving.

DANGER

Do not lend the watch or share the watch with another person while resting on the surface (during operation of the surface mode). In addition, the data displayed on the watch should never be used as the data for another diver. This watch is designed on the premise of personal use. Since data accumulated during the previous time is continued to be used while in the surface mode, the use of the watch by another person will prevent data from being calculated that is suitable for that person and can lead to the risk of a fatal or serious accident.

DANGER

Avoid flying in an airplane when the surface mode is operating. Flying in an airplane without allowing an adequate amount of time for resting following diving can result in the risk of decompression sickness. It is recommended to avoid flying for at least 24 hours following the completion of diving whenever possible. There is no method for completely preventing decompression sickness caused by flying in an airplane after diving.

 **WARNING**

In the case of using this watch for diving, always make sure to use the watch in combination with other diving instruments (dive table, divers' watch, residual pressure gauge or water depth gauge).

Sudden atmospheric fluctuations and changes in water temperature may have an effect on the display and performance of the watch. In addition, always make sure to use the watch in combination with other diving instruments in case the watch should happen to malfunction.

 **WARNING**

Always make sure to inspect all functions of the watch before each dive to prevent malfunctions and accidents caused by the use of improper settings. In particular, make sure to check whether the watch is sufficiently charged and that there are no warnings displayed on the display.

 **WARNING**

The use of this watch for diving is limited to recreational diving (non-decompression diving) at a water temperature of 0°C to +40°C (32°F to 104°F).

Do not use this watch for the following types of diving:

- Diving outside the above temperature range
- Decompression diving
- Saturation diving using helium gas
- High-altitude diving at 3,000 m (10,000 ft) above sea level or higher
- Diving in water other than saltwater (water having a specific gravity of 1.025)

 **WARNING**

Allow a sufficient margin during diving with respect to the no-decompression diving limit time.



WARNING

In the case you happen to engage in decompression diving, immediately begin ascending to the surface while observing an ascent rate of no more than 9 m (30 ft)/minute according to a dive table.



WARNING

Do not engage in skin diving after scuba diving since this can have a serious effect on your health.
This watch does not incorporate a function for distinguishing between scuba diving and skin diving.



CAUTION

Storage of Log Data

Always make sure to keep a separate record of your important log data.

Various types of data stored by this watch may be lost in the following cases:

- (1) improper use of the watch
- (2) improper usage environment (where subjected to the effects of strong static electricity or electrical noise)
- (3) during malfunctions and repairs.

Introduction

Thank you for your purchase of this Citizen AQUALAND Eco-Drive watch. Please make sure to read this manual carefully before using your watch to ensure that it is used properly. Furthermore, store this manual in a safe place for future reference as necessary.

1. This watch is a combination divers watch equipped with a built-in water depth gauge.
 - (1) This watch is equipped with a water sensor that automatically switches the watch to the diving mode when water is detected.
 - (2) The following parameters are displayed during diving:
 - Current depth, current time, current water temperature, dive time and maximum depth are displayed on Digital Display.
 - Elapsed dive time is indicated with the minute hand.
 - Maximum depth is indicated with the function hand.
 - (3) The following can be performed after diving:
 - Log data recorded during diving (including log number, dive date, maximum depth, minimum water temperature and dive time) can be recalled.
2. This watch is also a solar-powered watch provided with a photoelectric power generation (Eco-Drive) function.

Expose the Watch to Light Before Using

Sufficiently charge the watch by exposing it to sunlight or other light before using until the function hand indicates level 5.

- Charge the watch by allowing light to shine on the solar cell (watch face) by referring to "2. General Reference for Charging Times" for information on the charge level indicator and continuous operating times.
- When charging with a fluorescent lamp or incandescent light bulb, be careful not to allow the watch to reach a high temperature by placing too close to the light source. If the watch is exposed to a high temperature of 60°C (140°F) or higher, the digital display will turn white and no longer be displayed. It will return to normal when the watch is returned to normal temperature.

Function hand

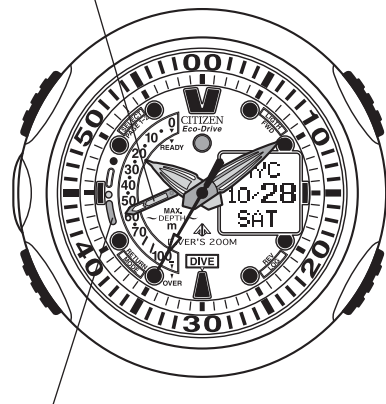

Charge level - "Level 5"

Features

This watch is provided with various convenient functions for diving.

1. Measurement begins automatically and parameters including depth, water temperature, dive time and maximum depth are displayed on the digital display simply by putting on the watch and entering the water.
2. Various warning functions are provided for safe diving.
 - (1) A depth alarm sounds and the LED flashes when the set depth has been exceeded, and a dive time alarm sounds along with the LED flashing when the set dive time has been exceeded.
 - (2) An ascent warning "SLOW" is displayed on the digital display in the case of a rapid ascent.
3. Up to 20 sets of diving log data are automatically stored in memory.

This watch is provided with a convenient Eco-Drive function.

1. This watch is a solar-powered watch that contains a solar cell in its face that drives the watch by converting light energy into electrical energy.
2. Once fully charged, the watch will continue to run for about six months.
 - The continuous operating time varies according to the frequencies at which the alarm, EL light and diving functions are used.
3. An environmentally-friendly secondary battery that is completely free of mercury and other harmful substances is used for the power supply of this watch.
4. This watch is also equipped with the functions described below.

Charge Level Indicator Function: A general indication of the charge level of the secondary battery is displayed with the function hand to one of six levels.

Insufficient Charge Warning Function: The second hand begins to move at two-second intervals and [ : Insufficient charge mark] is displayed on the digital display to indicate that the watch is insufficiently charged.

Power Save 1: The second hand stops at the 12:00 position to save on power.

Power Save 2: The hour hand, minute hand and second hand stop at the 12:00 position to further save on power.

Overcharge Prevention Function: The overcharge prevention function is activated to prevent the watch from being charged further when the secondary battery becomes fully charged.

Other Convenient Functions

1. **Travel Time Function:** This function lets you easily display the local time when traveling overseas or traveling on business. In addition, daylight savings time can be set for each city.
2. **Alarm:** This watch is equipped with three alarm modes. (The alarm tones are different.)
3. **EL light Function:** An EL light function is provided to make it easier to see the display in dark locations.
4. **Wide Digital Display:** An easily legible, dot matrix display having a wide angle of view is used.

Names of Components

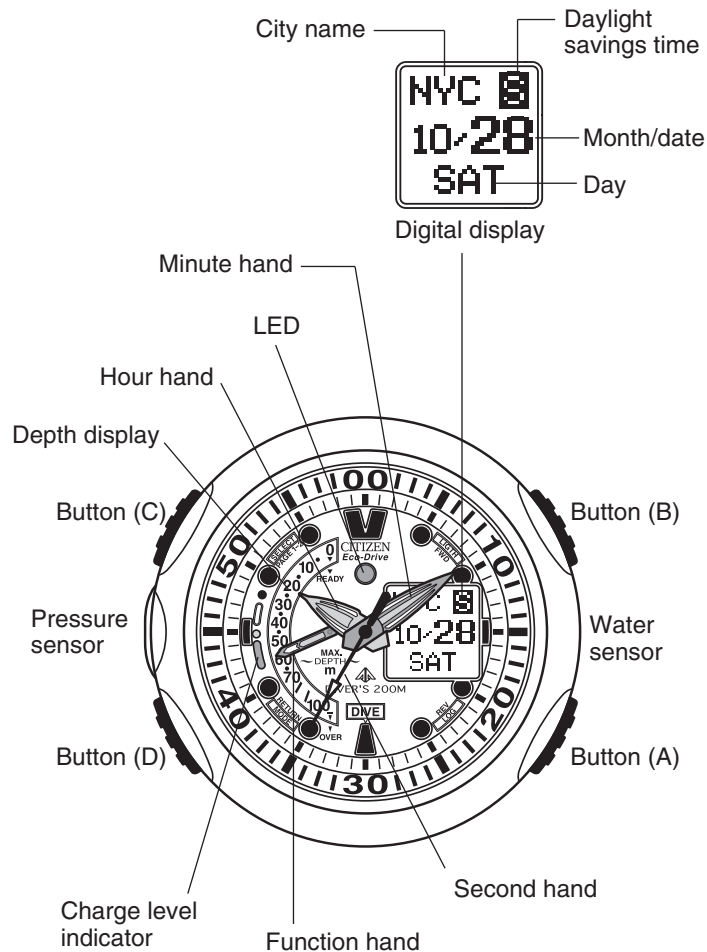

The illustrations shown in this manual may differ from the actual watch you have purchased.

[Digital Display]







- A dot matrix display using a nematic liquid crystal is used for the digital display.
- This nematic liquid crystal automatically scrolls the digital display from top to bottom when displaying a mode or when making corrections. Although the display may appear to flicker while scrolling, this is not a malfunction. Furthermore, the timing of display scrolling differs according to the mode and correction state.
- The display is no longer displayed when the temperature of the watch reaches 60°C (140°F) or higher. It returns when the watch temperature returns to normal temperature.

Charge Level Indicator and Continuous Operating Times

The charge level indicator (reference value) lets you confirm the extent to which the secondary battery is charged with the function hand. The charge level indicator is divided into six levels. The level indicated by the function hand is the current charge level of the secondary battery.

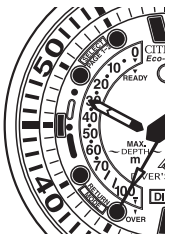
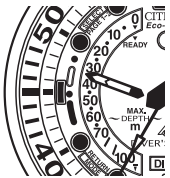
Try to keep the watch charged to level 5 at all times.

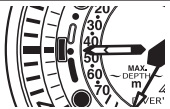
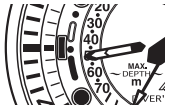
Secondary Battery Charge Levels

Level	Charge level indicator	Continuous operating time (reference)	Description of watch operation at indicated charge level
Level 0		Approx. 2 days	<ul style="list-style-type: none"> • Watch is insufficiently charged. It cannot be used for diving. Promptly recharge the watch. • "Charge" is displayed and the second hand moves at 2-second intervals. • Measurement of water depth is interrupted if the charge level indicator falls to level 0 (log data is not stored in memory). • The watch cannot be switched to other modes such as the travel time and alarm modes. • The EL light is not illuminated.
Level 1		Approx. 4 days	<ul style="list-style-type: none"> • The water sensor is not activated and the watch cannot be used for diving due to the watch being insufficiently charged. • The watch cannot be used in the standard mode. • The insufficient charge mark is displayed on the digital display when the charge level falls to level 1 during depth measurement. • The EL light is not illuminated.
Level 2		Approx. 7 days	<ul style="list-style-type: none"> • The charge level remaining in the secondary battery is low. • The watch can be used for about 1 hour of diving. • The EL light is not illuminated.
Level 3		Approx 2 months	<ul style="list-style-type: none"> • All functions can be operated.
Level 4		Approx. 4 months	
Level 5		Approx. 6 months	

1. Reading the Charge Level Indicator

The charge level of the secondary battery changes according to the conditions of use, the passage of time and the manner in which the watch is recharged.

- The charge level of the secondary battery (reference value) and changes in the charge level indicator are represented schematically in the illustrations. The design may differ somewhat depending on the model.

2. General Reference for Charging Times

The time required for charging varies according to the model of the watch (color of the dial, etc.). The following times are shown below to serve only as a reference.

Illuminance (lx)	Environment	Charging time		
		Approx. charging time required for 1 day of operation	Charging time until hour hand begins to move from stopped state	Charging time to fully charged from stopped state
500	Inside an ordinary office	Approx. 3.5 hours	Approx. 30 hours	----
1,000	60-70 cm (24-28 in) under a fluorescent lamp (30 W)	Approx. 2 hours	Approx. 15 hours	----
3,000	20 cm (8 in) under a fluorescent lamp (30 W)	Approx. 35 minutes	Approx. 6 hours	Approx. 150 hours
10,000	Outdoors, cloudy weather	Approx. 10 minutes	Approx. 2 hours	Approx. 45 hours
100,000	Outdoors, summer, under direct sunlight	Approx. 2 minutes	Approx. 45 minutes	Approx. 9.5 hours

- Try to recharge the watch before it becomes insufficiently charged. There is no risk of overcharging the watch no matter how frequently it is charged (overcharge prevention function). It is recommended to try to recharge the watch daily.

3. Continuous Operating Time

This watch will continue to run for about six months when fully charged.

[NOTE]

- The continuous operating time of this watch becomes shorter the more often the diving mode, dive alarms, EL light and other functions of this watch are used.
- Allowing the watch to become wet other than when diving causes activation of the water sensor resulting in a shortened continuous operating time.

Unique Functions of Solar-Powered Watches

When the watch has become insufficiently charged, it changes from the normal hand display to the insufficient charge warning display (the second hand moves at 2-second intervals and "Charge" is displayed on the digital display). Recharge the watch by exposing it to light while referring to "2. General Reference for Charging Times" until the function hand indicates level 5.

[Normal Hand Display]

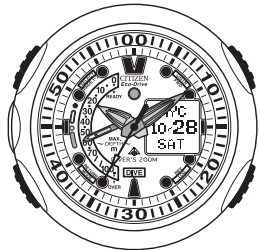

When the watch becomes insufficiently charged as a result of not being exposed to light

[Insufficient Charge Warning Display]

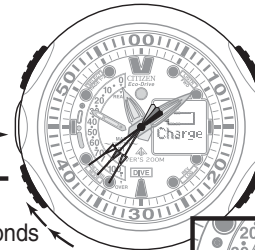

If the watch is continued to be used without charging

[Stopped]

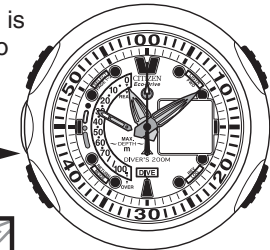

Second hand stops at 0 seconds position

When the watch is charged by exposing to light

2 seconds
2 seconds

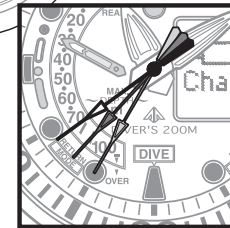

Second hand moves at 2-second intervals

Charge the watch by exposing to light until the function hand indicates a charge level 5. Use the watch after first resetting the time and date.

[Insufficient Charge Warning Function]

When the watch becomes insufficiently charged, the second hand changes from 1-second interval movement to 2-second interval movement. The battery mark and "Charge" are also displayed on the digital display.

If the watch is continued to be used while insufficiently charged, it stops running after about 2 days. Promptly expose the watch to light and recharge it to level 5.

<The functions of the watch are limited in the following manner when the watch becomes insufficiently charged.>

- Water sensor is not activated and the watch cannot be used for diving.
- The mode cannot be changed and corrections and settings cannot be made even if the buttons are pressed.
- The alarm does not sound.
- The EL light is not illuminated.

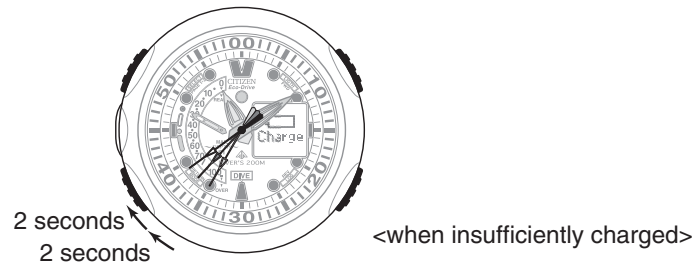

[Overcharge Prevention Function]

The overcharge prevention function is activated automatically when the watch face (solar cell) is exposed to light and the secondary battery is fully charged to prevent the battery from being charged further. The secondary battery and accuracy, functions and performance of the watch are unaffected no matter how much the watch is charged.

[Power Save 1 Function] ... The second hand stops at the 0 seconds position when the Power Save 1 function is activated.

When power is not generated as a result of the watch not being exposed to light for two consecutive hours when in the standard mode, the second hand stops at the 0 seconds position and the watch automatically enters the power save mode to reduce power consumption.

<The hands and digital display appear as described below.>

- Second hand: Stops at the 0 seconds position.
- Hour and minute hands: Continue to keep the current time.
- Function hand: Indicates the charge level.
- Digital display: Displays the city name and date.
- The alarm sounds at the set alarm time.

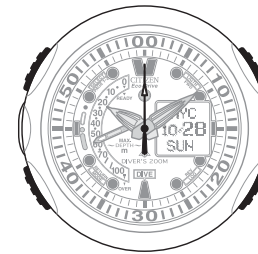

<Second hand stops at 0 seconds position>

Canceling Power Save 1:

- Power save 1 is canceled either when the solar cell is exposed to light and the watch begins to generate power or a button is pressed switch the watch on.
 - Power save 1 is also canceled when the water sensor is activated and the watch is switched to the diving mode.
- When power save 1 has been canceled, the second hand rapidly advances to the current time (seconds) and begins 1-second interval movement.

[Power Save 2 Function] ... The hour and minute hands stop at the 12:00 position when power save 2 is activated.

If the watch remains in the power save 1 mode for 7 days, it switches to the power save 2 mode to further reduce power consumption.

<The hands and digital display appear as described below.>

- Second hand: Stops at the 0 seconds position.
- Hour and minute hands: Stop at the 12:00 position.
- Function hand: Indicates the charge level when the watch entered the power save 2 mode.
- Digital display: The entire display goes out.

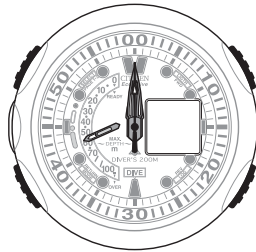

<Hour and minute hands stop at the 12:00 position along with the second hand>

Canceling Power Save 2:

- Power save 2 is canceled either when the solar cell is exposed to light and the watch begins to generate power. It cannot be canceled by pressing one of the buttons. In addition, it is also not canceled when the water sensor contacts water.

When power save 2 has been canceled, each hand rapidly advances to the current time (seconds) and begins to keep time. The digital display returns to the display of the city name and date.

Watch Display Modes (Functions)

[Standard Mode]

The watch is normally used in this mode. The standard mode contains the modes indicated below.

1. Time/Date Mode

- The hands indicate the time while the digital display displays the city name and date.

2. Surface Mode

- This displays the elapsed time from completion of the most recent dive (up to 24 hours).
- The surface mode is not displayed after measuring for 24 hours.

3. Travel Time Mode

- The time and date are displayed for a city different from that of the time/date mode.

4. Alarm 1, 2 and 3 Modes

- The set time and city name are displayed for each alarm.

5. Dive Alarm Setting Mode

- This can be used to set depth and dive time.

6. Diving Log Recall Mode

- This mode is used to confirm log data automatically recorded during the diving mode.

7. Reference Position Check Mode

- This indicates the reference positions of the watch hands.

[Diving Mode]

When the water sensor detects water, the watch automatically switches to the Diving Ready "READY Display". This mode changes in the manner described below depending on the diving status. However, the watch will not switch to the diving mode when it is insufficiently charged.

1. Diving Ready 1 Status

- "READY" and "ready" are alternately displayed on the digital display.

- Each hand continues to indicate the mode prior to entering Diving Ready 1.

Example: The current time is displayed during the display of time and date.

In addition, when the water sensor is switched off and Diving Ready 1 is canceled, the watch returns to the mode prior to entering Diving Ready 1.

2. Diving Ready 2 Status

- The watch changes to the Diving Ready 2 Status when the water depth remains below 50 cm (2 ft) while in Diving Ready 1 Status.
- Digital display: Alternately displays the "Current time" and "READY".
- Hour and minute hands: Move to the 12:00 position and stop.
- Second hand: Indicates the current time (seconds).
- Function hand: Moves to the 0 position on the depth scale and stops.

3. Water Depth Measurement Status

- The current time, depth, water temperature and dive time are displayed on the digital display.
- Hour hand: Stops at 6:00 to indicate that measurement of water depth is in progress.
- Minute hand: Indicates the elapsed dive time (minutes). (It continues to indicate the elapsed time even after measuring for 60 minutes.)
- Second hand: Indicates the current time (seconds).
- Function hand: Indicates the most recent depth.

The location where "current depth" or "maximum depth" is displayed switches automatically when the position of the minute hand is between 15 and 30 minutes.

<When minute hand indicates a time other than between 15 and 30 minutes>

<When minute hand indicates between 15 and 30 minutes>

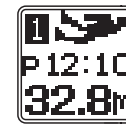

Current depth

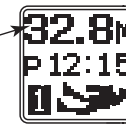

Current depth

4. When Having Returned to a Shallow Depth of within 1 m (4 ft) After Diving

- The watch remains in the water depth measurement status (the displayed depth is 0 m).
- The watch switches to the surface mode when the 0 m (0 ft) display continues for 10 minutes or more after diving or when button (D) is pressed while 0 m (0 ft) is displayed.

<when having returned to a shallow depth of within 1 m (4 ft)>



Current depth

Switching the Mode

- The watch mode switches in the order of the Time/Date, Surface, Travel Time, Alarm 1, Alarm 2, Alarm 3, Dive Alarm Setting, Diving Log Recall and Reference Position Check modes each time button (D) is pressed.
- When the water sensor detects water, the watch automatically switches to "Diving Ready 1 Status" of the Diving Mode.

[Button Operations]

- The mode cannot be changed by pressing a button while the mode is changing or while the hands are moving when making a correction. Press the desired button after waiting until the hands have stopped at their predetermined positions.

[NOTE]

- The surface mode is not displayed after measuring for 24 hours.
- The watch automatically returns to the time/date mode from any mode when none of the buttons have been pressed for about 1 minute in a mode other than the time/date mode.
- The watch automatically returns to the time/date mode from the reference position check mode when none of the buttons have been pressed for about 10 minutes.
- The watch will not change to the diving mode even if the water sensor becomes wet while "Charge : Insufficiently charged" or "Error mark" is lit and a warning function has been activated.

Be careful not to touch the water sensor when switching the mode. The mode will not be able to be switched if the watch has entered the diving mode after having touched the water sensor before switching the mode. If the watch has entered the diving mode, wait until the watch returns to the time/date mode.

[Standard Mode]

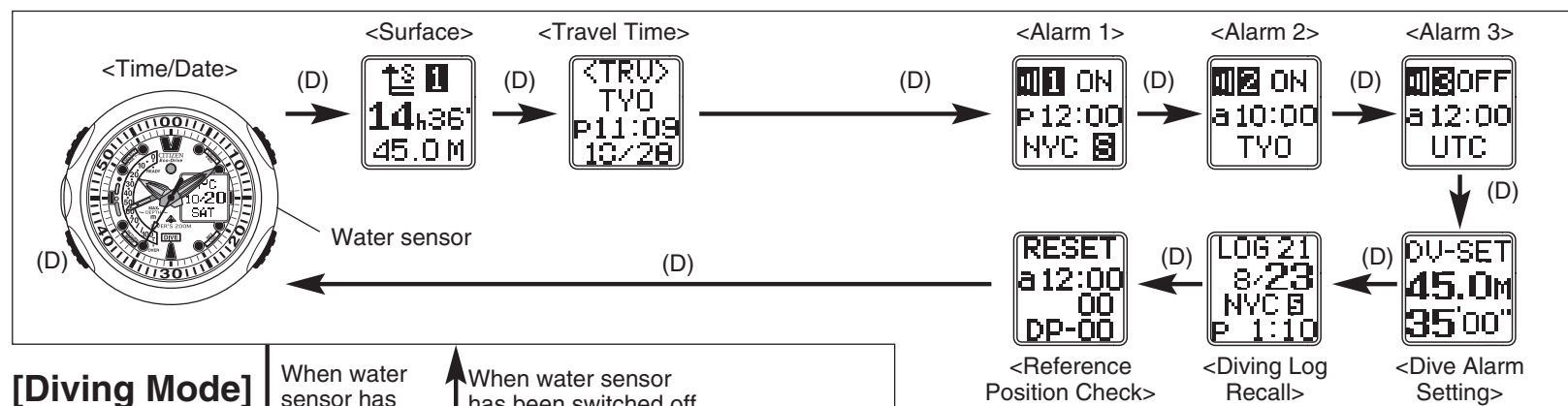

[Diving Mode]

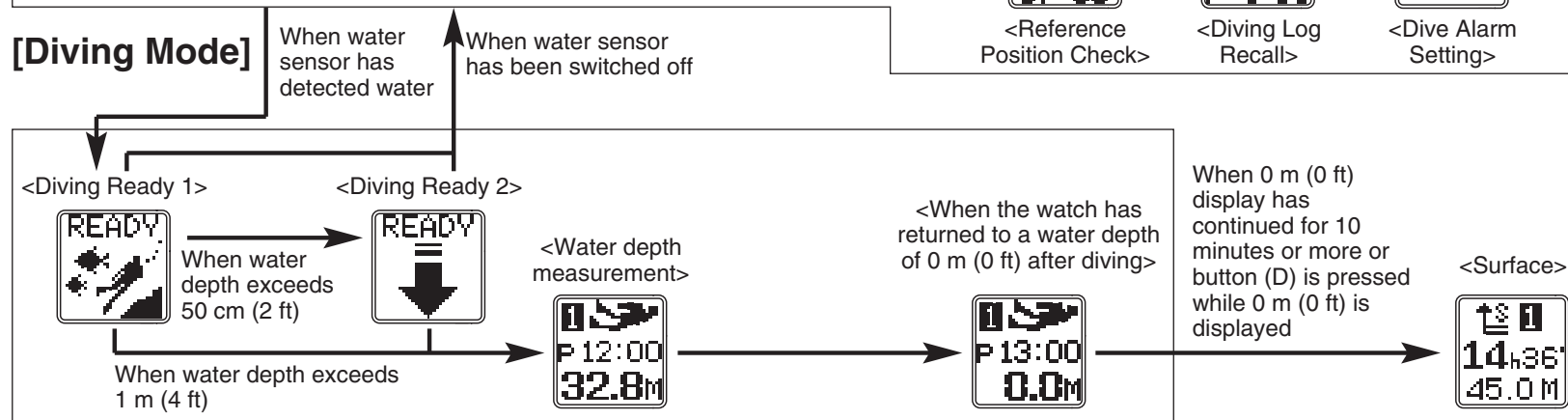

Using the Standard Mode

1. Using the Time/Date Mode

This mode indicates the time with the hands and displays the date on the digital display. The function hand indicates the charge level of the secondary battery.

A. Setting the Time and Date

• **Analog time cannot be corrected independently. The analog time is corrected automatically when the digital time is corrected.**

- (1) The watch enters the correction state when button (C) is pressed for about 2 seconds in the time/date mode.
 - Digital display: Changes to "seconds" and flashes.
 - Hour, minute and second hands: Move to 12:00 and stop.
 - If the second hand does not stop at the 12:00 position, press button (B) to set it to 12:00. The second hand moves 1 second when button (B) is pressed. Continuously depressing button (B) causes the second hand to move continuously.
- (2) The flashing location on the display changes in the order shown below each time button (C) is pressed.

- (3) Correct the flashing location by pressing button (B) or button (A).
 - The display moves forward by one each time button (B) is pressed.
 - The display moves back by one each time button (A) is pressed.
 - Depressing either button continuously causes the display to advance rapidly.
- (4) The watch returns directly to the normal display when button (D) is pressed in the correction state.

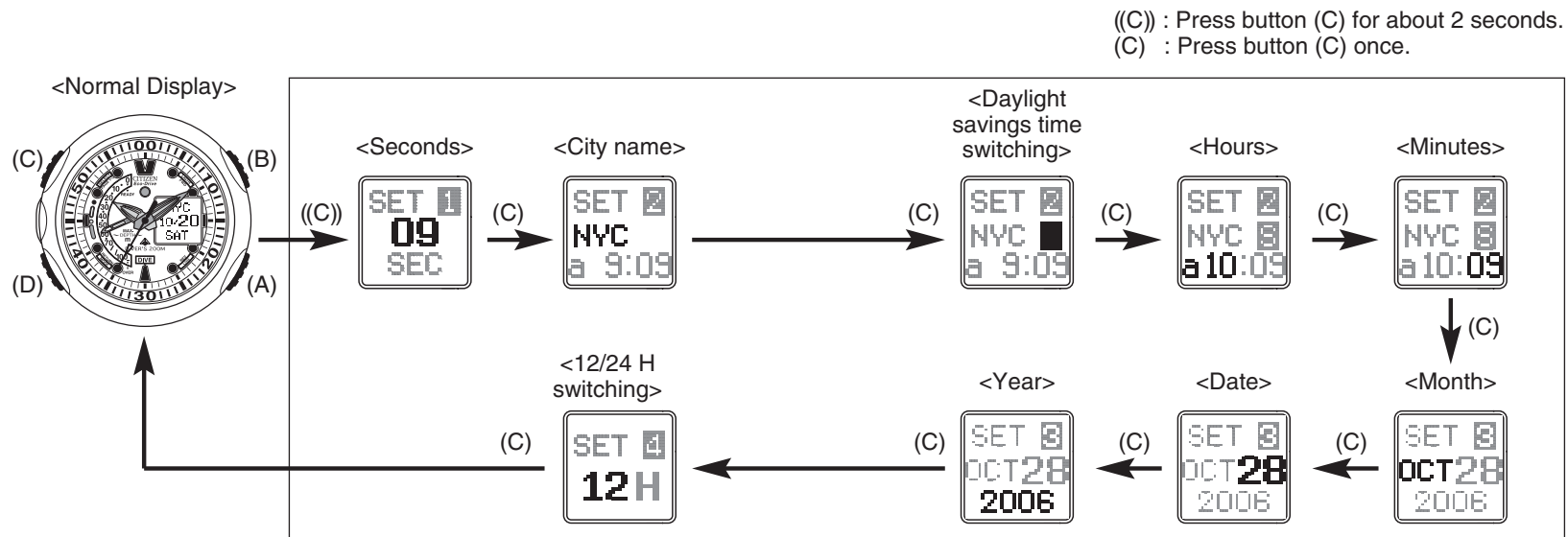

- The display returns to “0 seconds” when button (A) is pressed while correcting the “digital seconds”. The second hand moves when button (B) is pressed. Always make sure to correct the “digital seconds” with button (A).
- Refer to "Displayed Cities" for information on city names.
- The display for daylight savings time and 12/24 H clock change whenever button (A) or button (B) is pressed.
- When daylight savings time has been set, the time is advanced by 1 hour from the current time and "S" is displayed on the display.
- The daylight savings time cannot be set for UTC (Coordinated Universal Time).
- The month is displayed using three letters (JAN, FEB, . . . DEC) when correcting, and displayed using numbers (1, 2, . . . 12) when the watch is returned to the normal display.
- The year is displayed and can be set from 2000 to 2099.
- The day is corrected automatically by correcting the year, month and date.
- Pay attention to AM (a) and PM (p) when the watch has been set to a 12 H clock display.
- The watch automatically returns to the normal display when none of the buttons have been pressed for about 1 minute in the correction state (flashing display).

2. Using the Surface Mode

The surface mode displays the elapsed time from completion of the most recent dive (surface rest time). This mode measures the elapsed time for up to 24 hours and is no longer displayed after measurement has been completed.

WARNING

- **Avoid flying in an airplane while the surface mode is operating.**
Flying in an airplane without allowing an adequate time for resting following diving can result in the risk of decompression sickness. There is no method for completely preventing decompression sickness caused by flying in an airplane after diving.

[Surface Mode]

- **Digital display:** Display 1: Displays surface time and maximum depth.
Display 2: Displays surface time and dive time.
- **Hour, minute and second hands:** Indicate the time in the time/date mode.
- **Function hand:** Indicates the charge level.

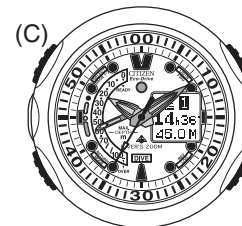

Surface Mode

- The display can be switched by pressing button (C).

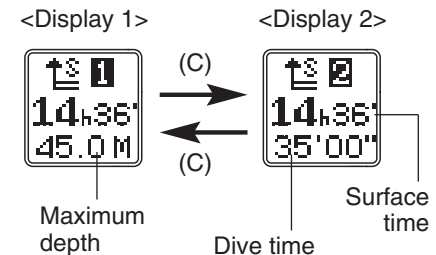

[The surface mark is displayed in the time/date mode while the surface mode is operating.]

<Time/date display>



[NOTE]

- When the measured time reaches 24 hours 00 minutes while the surface mode is displayed, the surface mode ends and the time/date mode is displayed. The surface mode is longer displayed after this time.

3. Using the Travel Time Mode

This mode is used to display the time and date of a selected city by selecting a city name from UTC and 42 cities registered in this watch.

- Digital display: Displays the name of the selected city and the time and date in that city.
- Hour, minute and second hands: Indicate the time in the time/date mode.
- Function hand: Indicates the charge level.

A. Setting Travel Time

- (1) A city name flashes when button (C) is pressed for about 2 seconds in the travel time mode.
 - The hour and minute hands move to 12:00 and stop.
- (2) Switch the city name by pressing button (A) or button (B).
 - City names are recalled moving in the direction in which the time difference increases when button (B) is pressed. City names are recalled moving in the direction in which the time difference decreases when button (A) is pressed.
 - The city name can be switched continuously by depressing either button continuously.
 - Refer to "Displayed Cities" for information on cities displayed by this watch.
- (3) The watch enters the daylight savings time correction state when button (C) is pressed.
 - The "S" mark (daylight savings time set) or "■" mark (daylight savings time canceled) flash.
- (4) Correct by pressing button (A) or button (B).
 - The "S" and "■" marks change back and forth each time a button is pressed.
- (5) The watch returns directly to the normal travel time display when button (D) is pressed while in the correction state.

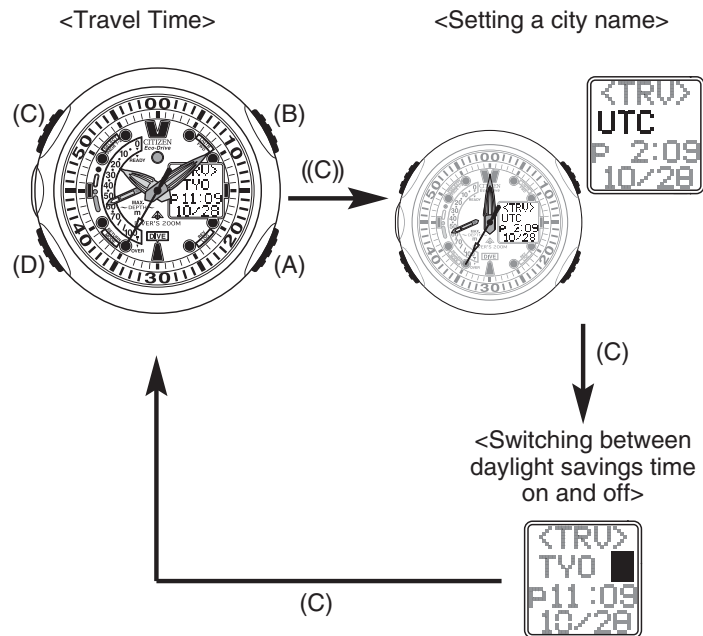

B. Switching Between Travel Time and Time/Date Modes

City names and times displayed in the travel time mode can be easily switched with city names and times displayed in the time/date mode.

- The time and date for a frequently traveled city displayed in the travel time mode can be displayed directly in the time/date mode by setting that city in the travel time mode and then switching to that city when traveling.
- The time and date in the city displayed in the time/date mode are transferred to the travel time mode.

- The setting for the 12/24 H clock is the same as that set in the time/date mode.
- When daylight savings time has been switched in the travel time mode, it is also applied to the same city in the time/date mode and alarm mode.
- Daylight savings time cannot be set for UTC (Coordinated Universal Time).
- The watch automatically returns to the normal travel time display when none of the buttons have been pressed for about 1 minute in the correction state.
- The watch automatically returns to the time/date mode from any mode when none of the buttons have been pressed for about 1 minute while in the travel time mode.

<Procedure>

(1) Press buttons (A) and (C) simultaneously for about 2 seconds in the travel time mode.

- The time in the travel time mode and the time in the time/date mode are interchanged.

Example: Tokyo (TYO) is set for the travel time and New York (NYC) is set in the time/date mode. The displays for these two cities can be switched as described below.

① Press buttons (A) and (C) simultaneously for about 2 seconds.

- The hour and minute hands change from the time in NYC to the time in TYO.
- The travel time display changes from the time and date in TYO to the time and date in NYC.

(2) When button (D) is pressed and the watch is returned to the time/date mode:

- The hour and minute hands display the time in TYO.
- The digital display changes from NYC to TYO.

[Display Before Switching]

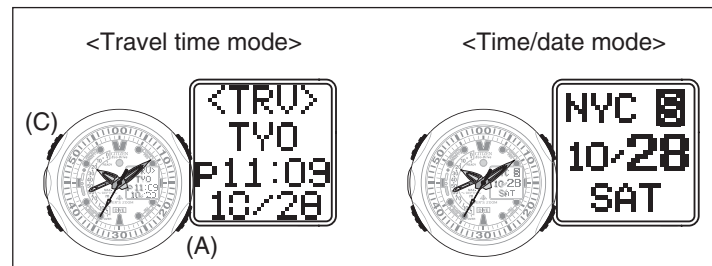

[Display After Switching]

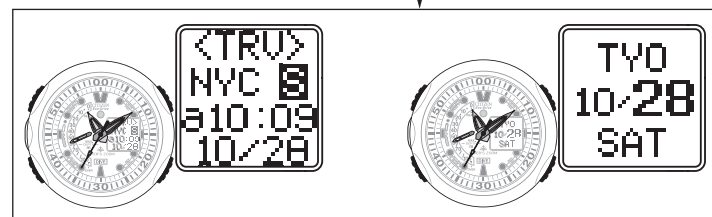

4. Using the Alarm Mode

The procedures for setting the alarm and operating the Alarm 1, Alarm 2 and Alarm 3 modes are the same. Only the alarm tone is different.

- Digital display: Display the set city name and set alarm time.
- Hour, minute and second hands: Indicate the time in the time/date mode.
- Function hand: Indicates the charge level.

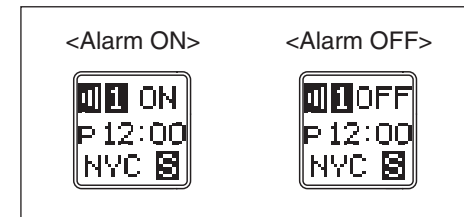
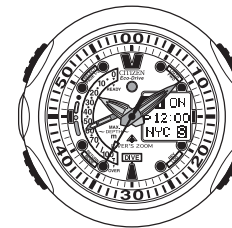

A. Setting the Alarm

- (1) When button (C) is pressed for about 2 seconds in the normal alarm mode display, ON or OFF flashes on the digital display and the watch enters the correction state.
 - The hour and minute hands move to 12:00 and stop.
- (2) The flashing location on the display changes in the order shown below each time button (C) is pressed.

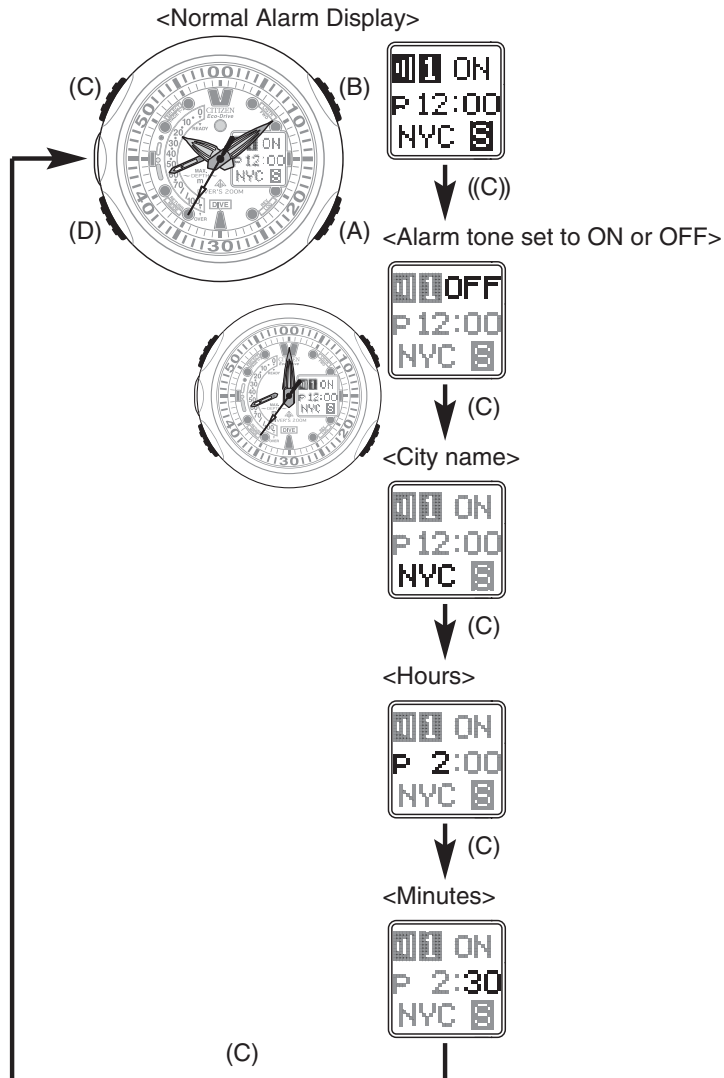

- (3) The flashing location is corrected by pressing button (A) or (B).
 - The display moves forward by 1 each time button (B) is pressed.
 - The display moves back by 1 each time button (A) is pressed.
 - Depressing either button continuously causes the display to advance rapidly.
- (4) The watch returns directly to the normal alarm display when button (D) is pressed in the correction state.
 - The hour and minute hands return to the time in the time/date mode.

- Once the alarm is set to ON, it sounds for about 15 seconds at the same time every day.
- When the alarm is set to ON when the time/date mode is displayed, the alarm sounds when the set time is reached, and the city name and set time are displayed on the digital display while the alarm is sounding.
- Press any button to stop the alarm while it is sounding.
- The alarm tone can be monitored by pressing button (A) during the normal alarm display.
- The setting for the 12/24 H clock is the same as that set in the time/date mode.
- The watch automatically returns to the normal alarm display when none of the buttons have been pressed for about 1 minute in the correction state (flashing display).
- The on/off setting for daylight savings time in the time/date and travel time modes is applied to the on/off setting for daylight savings time of each city.
- The watch automatically returns to the time/date mode from any mode when none of the buttons have been pressed for about 1 minute during the normal alarm display.
- The alarm does not sound during diving even if it has been set to ON.

Displayed Cities

The following city names are registered in this watch. These city names are displayed in each of the time/date, travel time, alarm 1, alarm 2 and alarm 3 modes of the standard mode.

- City names are displayed moving in the direction in which the time difference increases when button (B) is pressed or city names are displayed in the direction in which the time difference decreases when button (A) is pressed when correcting the city name in each of the modes.

Watch display	City name	Time difference
UTC	Coordinated Universal Time	±0
LON	London	±0
PAR	Paris	+1
ROM	Rome	+1
BER	Berlin	+1
MAD	Madrid	+1
CAI	Cairo	+2
JNB	Johannesburg	+2
ATH	Athens	+2
MOW	Moscow	+3
RUH	Riyadh	+3
THR	Teheran	+3.5
DXB	Dubai	+4
KBL	Kabul	+4.5
KHI	Karachi	+5
DEL	Delhi	+5.5
DAC	Dacca	+6
RGN	Yangon	+6.5
BKK	Bangkok	+7
SIN	Singapore	+8
HKG	Hong Kong	+8
BJS	Beijing	+8

← When button (B) is pressed
 ↑ When button (A) is pressed →

Watch display	City name	Time difference
TYO	Tokyo	+9
SEL	Seoul	+9
ADL	Adelaide	+9.5
SYD	Sydney	+10
NOU	Noumea	+11
AKL	Auckland	+12
SUV	Suva	+12
MDY	Midway	-11
HNL	Honolulu	-10
ANC	Anchorage	-9
LAX	Los Angeles	-8
YVR	Vancouver	-8
DEN	Denver	-7
CHI	Chicago	-6
MEX	Mexico City	-6
NYC	New York	-5
YMQ	Montreal	-5
CCS	Caracas	-4
RIO	Rio de Janeiro	-3
FEN	Fernando de Noronha	-2
PDL	Azores	-1

|| Precautions During Diving



WARNING

Using the Watch when Diving

The water depth measurement function of this watch is not permitted to be used as an official measuring instrument. The water depth value displayed on the watch should only be used for reference purposes. Diving is a potentially dangerous sport. When using this watch for diving, always make sure to receiving the proper diving instructions and training from a licensed instructor and obey the rules after having acquired the experience and skills required for safe diving. In addition, make sure you have completely mastered the handling and operation of this watch. Even recreational diving can be potentially dangerous. Diving without the proper or adequate training can lead to a fatal or serious accident.

1. **When using this watch for diving, make sure you have a proper understanding of the procedures for handling and operating the watch and observe those procedures.** Handling of this watch in a manner contrary to that described in this user's manual may prevent the watch from functioning properly.
2. **Always make sure to inspect all functions of this watch before diving to make sure they operate properly.**
3. **In the case of using this watch, always make sure to use the watch in combination with other diving instruments (such as a dive table, residual pressure gauge or water depth gauge).** Sudden atmospheric fluctuations and changes in water temperature may have an effect on the display and performance of the watch. The diving functions of this watch are not intended to prevent decompression sickness. The watch is only designed to display information that can be used as a reference to minimize the risk of decompression sickness, and is not intended to guarantee the safety of the user.



4. **The use of this watch for diving is limited to recreational diving (no-decompression diving) at a water temperature of 0°C to +40°C (32°F to 104°F).** Do not use this watch for the following types of diving:
 - Diving outside the above temperature range
 - Decompression diving
 - Saturation diving using helium gas
5. **Although this watch can measure depth to 100 m (300 ft), do not dive beyond the limit depth of 40 m (131 ft) during recreational diving.** It is recommended that recreational diving not exceed a depth of 18 m (60 ft).
6. **Allow a sufficient margin during diving with respect to the no-decompression diving limit time.**
7. **Make sufficient safety stops and decompression stops.** Even in the case of no-decompression diving, try to make a safety stop at a depth of 5 m (15 ft) to ensure safety.
8. **Do not lend the watch or share the watch with another person while resting on the surface (during operation of the surface mode). In addition, the data displayed on the watch should never be used as the data for another diver.**
9. **Make sure to allow for sufficient rest after diving in accordance with diving rules to ensure safety.** Failing to take the proper rest time, flying in an airplane or moving to a high altitude after diving can result in the risk of decompression sickness.



PROHIBITED

Prohibited Matters When Using During Diving

Do not use this watch for diving in the following cases.

1. **When diving prohibited [ : error mark] is displayed on the display.** The watch will not switch to the diving mode when the error mark is displayed.
2. **When the watch is insufficiently charged and [] is displayed on the display.** In the case the watch is insufficiently charged, the watch will not switch to the diving mode even if diving is begun.
3. **When the watch has stopped or malfunctioned.**
4. **When the watch is used outside the guaranteed temperature range or at an altitude above 3,000 m (10,000 ft).**
5. **Use during dangerous behavior or life-threatening situations**
6. **When used in a helium gas atmosphere (such as during saturation diving).**



WARNING

Precautions Before Diving

1. **Always make sure to inspect all functions of this watch prior to diving.**
 - Is the function hand indicating a charge level 5 or higher?
 - Are there any error marks displayed?
2. **When there is an extreme temperature difference between the temperature of the watch and the temperature of the water, first acclimate the watch to the temperature of the water before using by immersing in the water to ensure that the watch operates accurately.**
3. **Is the band securely attached to the watch body?**
4. **Are there any cracks, scratches or chips in the band or glass?**
5. **Are the time and date set correctly?**
6. **Are the alarm depth and alarm time set correctly?**



WARNING

Precautions During Diving

1. **Avoid ascending too rapidly.**
 - A rapid ascent can cause decompression sickness and other detrimental effects on the body. Maintain a safe ascent rate.
2. **Please note that while in the water, it may be difficult to hear the depth alarm or other alarm tones depending on the surrounding conditions and environment.** If this happens, check the LED while listening for the alarm tone.
3. **If the watch should happen to not operate properly while in the water, begin to ascend immediately.**
 - Immediately begin to ascend while observing an ascent rate of no more than 9 m (30 ft)/minute.
4. **Dive while allowing a sufficient margin for the no-decompression limit time to ensure safety.**
5. **In the case you happen to engage in decompression diving, immediately begin ascending to the surface while observing an ascent rate of no more than 9 m (30 ft)/minute.**
6. **When ascending, always make sure to make decompression stops according to a dive table to ensure safety.**



WARNING

Precautions After Diving

1. **Avoid flying in an airplane when the surface mode is operating.**
 - Make sure to rest sufficiently after diving.
 - It is recommended to avoid flying for at least 24 hours following the completion of diving.
2. **Carefully rinse off any seawater, mud or sand adhered to the watch and then wipe off any excess moisture with a dry cloth.**
3. **Remove any debris or dirt that has become trapped in the pressure sensor.**
 - If debris has become trapped in the pressure sensor, rinse it out with pure water.
 - Do not remove the sensor cover or poke the pressure sensor with a sharp object. In addition, do not blow highly compressed air onto the pressure sensor with an air gun.
 - Please consult with our service center if debris cannot be removed.
4. **Always make sure to store (record) important log data separately.**

|| Diving Terms

1. Diving

<No-Decompression Diving and No-Decompression Limit Time (NDL)>

No-decompression diving (no-decompression limit: NDL) refers to diving during which the diver is able to surface without stopping for decompression while ascending following the completion of a dive. The limit time during which this no-decompression diving is allowed is referred to as the no-decompression limit time. No-decompression limit time varies according to the diving depth and diving time of the previous dives.

<Decompression Diving>

This refers to diving beyond the no-decompression limit time. Decompression diving is extremely dangerous since nitrogen accumulates in the body beyond allowed levels. Do not engage in this type of diving.

<Decompression Stop>

This refers to stopping for the purpose of required decompression in the event of having engaged in decompression diving. It is necessary to make decompression stops at predetermined depths (decompression stop instructed depth) and at predetermined times (decompression stop instructed time) when ascending.

<Safety Stop>

This refers to a temporary pause while ascending in order to ensure safety and allow nitrogen to be dispelled from the body even if the no-decompression limit time has not been exceeded. In the case of diving to a depth of 18 m (60 ft) or more, always make a safety stop at a depth of 5 m (15 ft) to ensure safety.

<Dive Date>

This refers to the date on which a dive was made (year, month, date).

<High-Altitude Diving and High-Altitude Setting>

High-altitude diving refers to diving at a high location 300 m (1,000 ft) above sea level (such as in lakes, ponds or rivers). When diving in freshwater, water depth is displayed based on seawater (specific gravity: 1.025).

CAUTION

1. This watch is not equipped with a function that indicates decompression diving or no-decompression diving.
2. Make decompression stops and safety stops in accordance with a dive table.

2. Measurement of Water Depth

Water depth is measured every second, and the current depth is displayed in 0.1 m (1 ft) increments while diving.

- Measuring range: 1.0 (4 ft) to 100 m (300 ft)
 - A depth of 0.0 m (0 ft) is displayed when shallower than a depth of 1.0 m (4 ft), while "Over M" ("Over ft") is displayed at a depth of greater than 100 m (300 ft).
 - When there is an error in the measured value for water depth, the [] error mark is displayed instead of the diver mark.

<Maximum Depth>

This refers to the deepest depth of a single dive.

3. Measurement of Dive Time

The elapsed time of a dive to a depth of greater than 1.0 m (4 ft) is displayed.

<Dive Time>

This refers to the total amount of time at a depth of greater than 1.0 m (4 ft) for a single dive.

- Measurement of dive time starts automatically when the depth first exceeds 1.0 m (4.0 ft), and stops when the depth again becomes shallower than 1.0 m (4 ft). Dive time resumes from the time it stopped when water depth exceeds 1.0 (4 ft) within 10 minutes after measurement of dive time stopped.
- Dive time is displayed in minutes and seconds up to 99 minutes 59 seconds from the start of measurement and is displayed in minutes after that time.
- Measuring range: 0 minutes 00 seconds to 999 minutes 59 seconds. When the dive time has exceeded 999 minutes 59 seconds, measurement stops and <--'--> is displayed.

<Dive Starting Time>

This refers to the time when the water depth first exceeds 1.0 m (4 ft) after the start of a dive.

<Surface Rest Time>

This refers to the elapsed time from completion of a dive (surface rest time). This watch measures surface rest time for up to 24 hours in the surface mode.

4. Measurement of Water Temperature

Water temperature can only be measured while in the water. Measurement of water temperature begins after the water depth exceeds 1.0 m (4 ft), and the most recent water temperature is displayed in 1°C (1°F) units during diving.

- Measuring range: -9.9°C to +40.0°C (14°F to 104°F)
* "--°C" ("--°F") is displayed when the measuring range has been exceeded.

<Minimum Water Temperature>

This refers to the lowest water temperature during a single dive.

5. Recording of Log Data

Up to 20 sets of log data can be recorded. When the number of recorded logs has exceeded 20, the oldest log is deleted and new data is recorded in its place.

<Single Dive>

A single dive is defined to be from the time a water depth of 1 m (4 ft) was reached following diving mode ready status (start of dive) to termination of the diving mode.

6. Termination of the Diving Mode

- The watch returns to the surface mode when button (D) is pressed for about 2 seconds when 0.0 m (0 ft) is displayed following completion of diving.
- The watch automatically returns to the surface mode after about 10 seconds while 0.0 m (0 ft) is displayed following completion of diving.

|| Dive Alarm Functions

This watch is equipped with various dive alarm functions to avoid danger and problems as much as possible during diving.



WARNING

Do not engage in diving that causes a dive alarm function to activate. The degrees of danger vary according to experience, physical condition and diving conditions. Diving cannot be assumed to be safe simply because a dive alarm is not activated.



CAUTION

In the case a dive alarm has sounded while diving, first begin to ascend to a shallower depth at an ascent rate of no more than 9 m (30 ft)/minute to ensure safety. Since the risk increases the deeper you dive, multiple dive alarms may be activated and sound at the same time during diving.

1. Main Types of Dive Alarms and Situations in which Main Dive Alarm Function are Activated

The following indicates the main alarm functions provided by this watch along with the displays on which they are activated.

Type of dive alarm	Applicable situation	
	During use on land	During use while diving
Digital display error	●	●
Water sensor error	●	
Pressure sensor error	●	●
Measurement error (0 m/0 ft detection)	●	●
Diving log memory error	●	
Insufficient charge alarm	●	●
Depth measurement out of range alarm		●
Ascent rate alarm		●
Depth alarm (set by user)		●
Dive time alarm (set by user)		●

2. Explanation of Dive Alarm Functions

<Digital Display Error>

The display is not updated if there is defective continuity in the digital display caused by a strong impact.

- (1) The following functions are restricted during this error:
 - The time cannot be corrected and dive alarms cannot be set.
- (2) The hands move in the following manner during this error:
 - Second hand: Moves at 4-second intervals
 - Hour and minute hands: Continue to keep time.
 - Function hand: Displays the charge level.

<Digital display error>

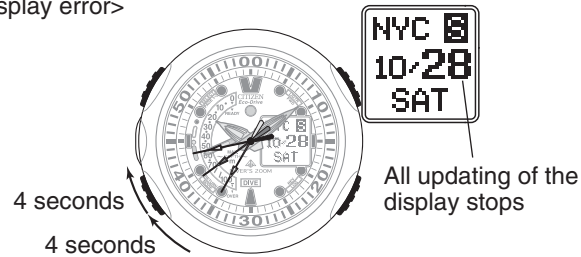

Second hand moves at 4-second intervals

When a Digital Display Error Occurs While Diving:

- (1) The following functions are restricted during this error:
 - Depth and water temperature measurements are not updated, and the digital display cannot be used.
- (2) The hands move in the following manner during this error:
 - Second hand: Moves at 4-second intervals
 - Hour hand: Pauses at the 3:00 position
 - Minute hand: Indicates dive time
 - Function hand: Indicates depth

<Digital display error while diving>

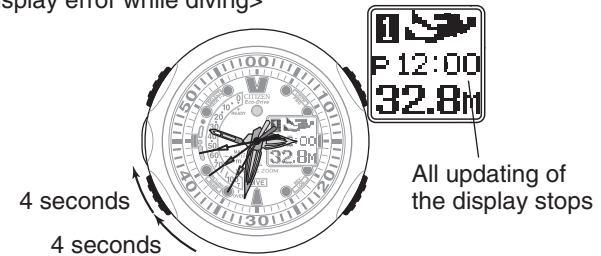

Second hand moves at 4-second intervals and hour hand paused at 3:00

Discontinue using the watch and begin ascending while observing an ascent rate of no more than 9 m (30 ft) / minute. Always make sure to make decompression stop instructions. Promptly have the watch inspected and repaired at our service center after surfacing.

<Water Sensor Error>

A water sensor error occurs and the alarm mark is displayed when the water sensor remains ON for more than 60 minutes in Diving Ready 1 or Diving Ready 2 status.

- When a water sensor error is detected, the watch returns to the time/date mode from the diving ready 1 or diving ready 2 display.

<Water sensor error>



Alarm mark

<Pressure Sensor Error>

When a pressure sensor error occurs as a result of a disconnection in the sensor caused by a strong impact or debris, stones or moisture having become trapped inside the sensor cover, the [] error mark is displayed on the digital display.

- The watch does not switch to the diving mode while an error mark is displayed.

When a Pressure Sensor Error Occurs While Diving:

Water depth and temperature cannot be measured. Data is also not updated. In addition, the various dive alarm tones do not sound.

- Digital display: The [] error mark is displayed.

Water depth display: "--.- M" ("--- ft")

Water temperature display: "--°C" ("--°F")

<Pressure sensor error during diving>



Alarm mark

<Measurement Error (0 m/0 ft Detection)>



Initial 0 m/0 ft detection: This refers to the value serving as the reference water depth, and atmospheric pressure is detected every 5 minutes when on land. The value measured at those times is stored in memory as a 0 m (0 ft) reference value.

- Although the initial 0 m (0 ft) value is updated after each measurement, a value that exceeds a predetermined value is considered to be in error and the reference value is no longer updated.
- In the case an abnormal value has been detected, the water sensor is judged to be in error and the [] error mark is displayed in the time/date mode.
- The watch cannot be used for diving when an error mark is displayed even if the water sensor has detected water since the watch does not enter the diving mode.

[Canceling Abnormal Measured Value]

- The abnormal measured value is canceled when a correct value has been detected after having detected an abnormal value.
- When the abnormal measured value is canceled, the error mark is no longer displayed and the water sensor begins to operate.

<Diving Log Memory Error>

- A “LOG**. ERROR” is displayed when the number of log data approaches the predetermined log capacity. When this capacity is reached, the [] error mark is displayed and the watch does not switch to the diving mode.
- When the [] error mark is displayed, the watch does not switch to the diving mode. Promptly have the watch repaired at a service center.

<Charge Alarm>

Try to keep the watch charged at level 5 at all times.

When Low Charge is Displayed during Diving:

The low charge mark is displayed on the digital display.

The following functions are restricted.

- The EL light does not light.
- Water depth will no longer measured and log data will not recorded if the diving is continued and the charge level is allowed to drop to 0.

<Low charge display during diving>

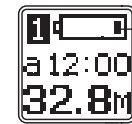

Low charge mark

When the Insufficient Charge Alarm is Displayed While Diving:

The second hand changes from 1-second to 2-second interval movement. "Charge" is displayed on the digital display.

The following functions are restricted during the insufficient charge alarm:

- Water depth is no longer measured.
- Log data is not recorded.
- None of the dive alarm tones sound.
- The LED flashes and the EL light lights.

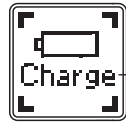

Insufficient charge alarm mark

- **If this alarm occurs while diving, immediately begin surfacing at a safe ascent rate.**

<Depth Measurement Error>

Depth is judged to be in error and the [] error mark is displayed if the difference between the measured depth and the depth measured one second earlier is ± 4 m (13 ft) or more.

- The depth measurement error mark is canceled following completion of depth measurement.

<Depth Measurement Out of Range Alarm>

When the current depth has exceeded 100 m (300 ft), the depth is judged to be beyond the measuring range and "Over M" / "Over ft" is displayed.

- The function hand indicates "OVER" and stops.

<Depth measurement error>

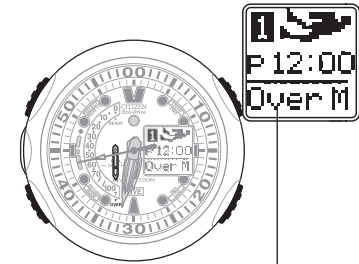

Out of range display

[Canceling Depth Measurement Out of Range Alarm]

- The depth measurement out of range alarm is canceled and the display returns to depth measurement once the current depth returns to the measuring range.
- The function hand continues to indicate "OVER" even after the depth has returned to the measuring range.

<Ascent Rate Alarm>

This alarm is activated when the ascent rate exceeds 9 m (30 ft)/minute. An alarm tone sounds when the ascent rate alarm is activated. At the same time, the LED flashes and "SLOW" is displayed on the digital display.

<Ascent rate alarm display>

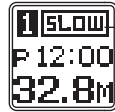

Ascent rate alarm

[Canceling the Ascent Rate Alarm]

- The dive alarm is canceled and the ascent rate alarm stops sounding when the ascent rate falls below the ascent alarm rate.

<Depth Alarm>

When the set depth is exceeded, the alarm is activated and an alarm tone sounds for 15 seconds simultaneous to the LED flashing.

If the set depth continues to be exceeded, the depth alarm tone sounds again and the LED flashes one minute later.

- The depth alarm tone can be turned off by pressing any button (A) through (D) while the depth alarm is sounding.

[Canceling the Depth Alarm]

- The alarm is canceled when the depth becomes shallower than the set depth. Ascend to a shallower depth at a safe ascent rate as quickly as possible.

<Dive Time Alarm>

When the set dive time is exceeded, the dive time alarm is activated and the alarm tone sounds for 15 seconds simultaneous to flashing of the LED.

- The dive time alarm is activated only once.
- The dive alarm tone can be turned off by pressing any button (A) through (D) while the dive time alarm is sounding.

Using the Diving Mode

This mode is for measuring depth while diving.

- The "Alarm Depth" and "Alarm Time" can be set in the dive alarm setting mode. Properly enter the values for these alarms according to the dive plan.
- The watch automatically switches to the diving mode when the water sensor detects water.

1. Using the Dive Alarm Setting Mode

- **Depth alarm:** The alarm sounds and the LED flashes when the set depth is reached. The water depth can be set in 1 m units from 5 m to 99 m (in 5 ft units from 5 ft to 295 ft).
- **Dive time alarm:** The alarm sounds and the LED flashes when the set dive time is reached. The dive time can be set in 1 minute units from 5 minutes to 99 minutes.

A. Normal Display in Dive Alarm Setting Mode

The display changes as indicated below when the watch enters the dive alarm setting mode.

- **Digital display:**
 - The previous settings (for alarm depth and alarm time) are displayed.
 - " - - " is displayed when dive alarms have not been set.
- **Hands:**
 - Hour and minute hands: Move to 12:00 and stop.
 - Second hand: Continues to move at 1-second intervals.
 - Function hand: Indicates the charge level.

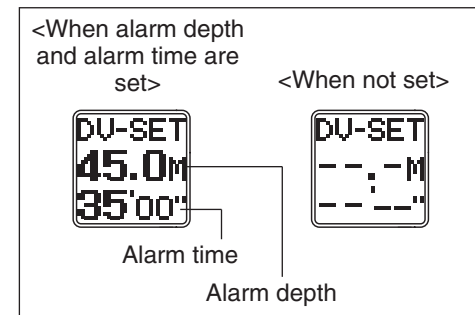
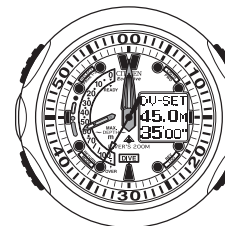

B. Setting Dive Alarms

- (1) When button (C) is pressed for about 2 seconds in the dive alarm setting mode, "ON or OFF" flashes on the digital display and the watch enters the correction state.
- (2) The flashing location on the display changes in the order shown below each time button (C) is pressed.

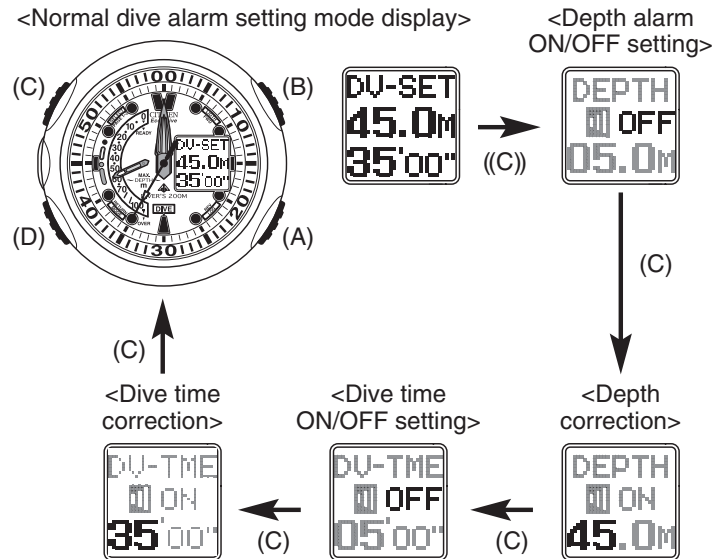

((C)) : Press button (C) for about 2 seconds.
 (C) : Press button (C) once.

- (3) The depth alarm and dive time alarm are switched ON and OFF by pressing button (A) or (B).

- (4) The depth alarm and dive time alarm are corrected by pressing button (B) or (A).
 - The display moves forward by one each time button (B) is pressed.
 - The display moves back by one each time button (A) is pressed.
 - The display can be corrected continuously by depressing either button continuously.
- (5) The watch returns to the normal display of the dive alarm setting mode when button (D) is pressed while in either correction state (flashing display).

- The watch automatically returns to the normal display of dive alarm setting mode when none of the buttons have been pressed for about 1 minute in the correction state (flashing display).
- The watch automatically returns to the time/date mode when none of the buttons have been pressed for about 1 minute during the normal display of the dive alarm setting mode.

2. Switching to the Diving Mode

- The watch automatically switches to "Diving Ready 1" of the diving mode when the water sensor detects water. The watch cannot be switched to the diving mode by pressing a button.

[When the Watch is Switched to the Diving Mode]

- When the watch reaches a depth of more than 50 cm (2 ft) in Diving Ready 1, it switches to "Diving Ready 2".
- When the watch reaches a depth of more than 1 m (4 ft) in Diving Ready 1 or Diving Ready 2, it automatically begins to measure depth.
- During depth measurement, information including the current depth, dive time and maximum depth are displayed.

<Displayed Data>

The display is switched by pressing button (C) during depth measurement.

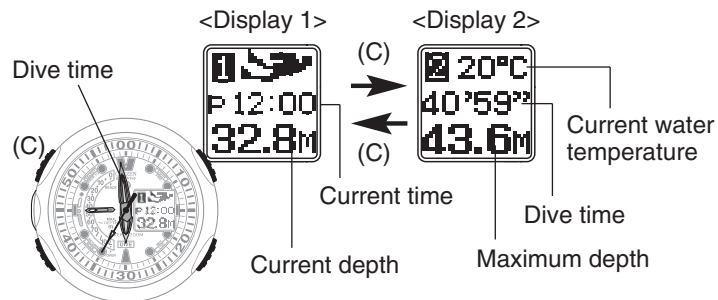

<Conditions for Storing Log Data in Memory>

- The log number and log data are stored in memory when the watch remains at a depth of more than 1 m (4 ft) for 3 minutes or more, or it remains at a depth of more than 8 m (27 ft) for 1 minute or more.

<Stored Log Data>

- Dive starting date
- Time and date in time/date mode
- Dive starting time (time when measured depth of 1 m (4 ft) or more)
- Maximum depth
- Minimum water temperature
- Dive time

[The display changes in the following manner according to dive status]

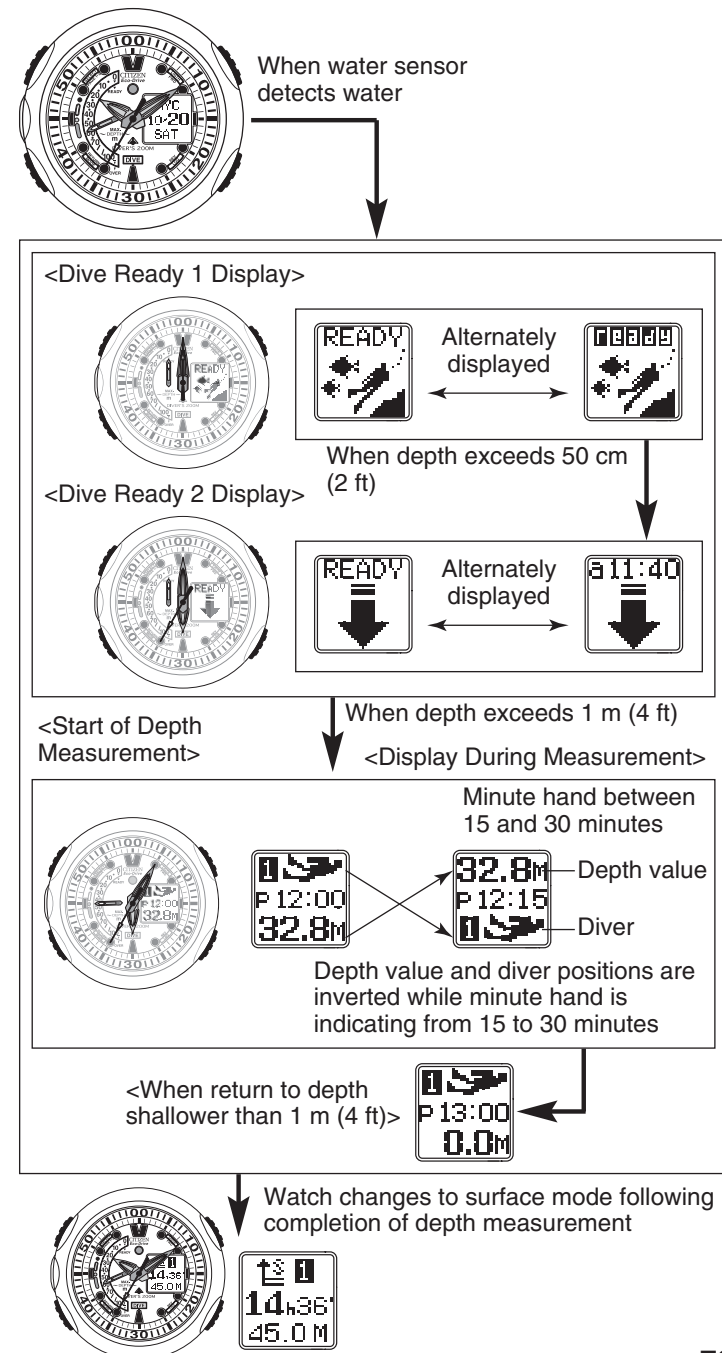

WARNING

- Always make sure to check that all functions of the watch are operating properly before starting a dive.
- Check that the function hand indicates "Charge Level 5".
- Always make sure to check that there are no warning displays on the display.
- The watch will not switch to the diving mode if any of the dive alarm functions such as "Charge: Insufficient Charge Alarm" or "  : error mark" have been activated in the time/date mode.
- Never engage in diving that requires decompression stops (decompression diving). In the case you happen to engage in decompression diving, immediately begin ascending to the surface while observing an ascent rate of no more than 9 m (30 ft)/minute. When ascending, always make sure to make decompression stops according to the decompression stop instructions. This watch does not incorporate a function that notifies the user of decompression diving. Confirm decompression diving by using this watch in combination with other devices.
- When making a decompression stop, never ascend to a depth shallower than the instructed depth according to decompression stop instructions.

Using the Diving Log Recall Mode

- Recorded log data are automatically displayed in the diving mode.
- Up to 20 sets of log data can be recorded.
- When the number of recorded logs has exceeded 20, the oldest log is deleted automatically when a new dive is started.
- A single set of log data is displayed on displays 1 and 2. The display is switched by pressing button (C).

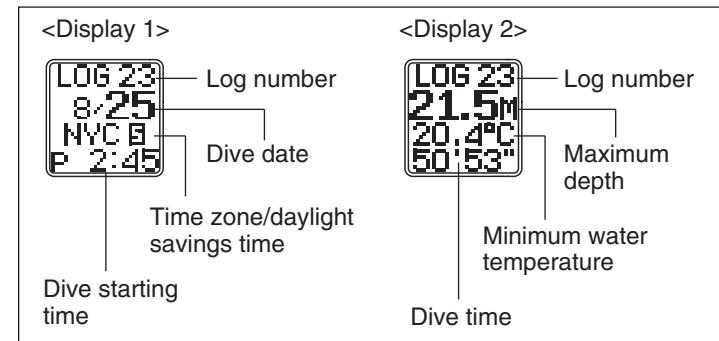
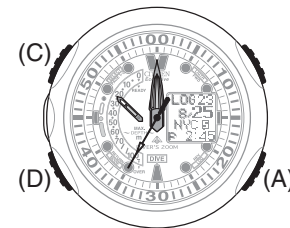

A. Log Data Display Range

- **Log number:** 01 to 99, 00, 01, 02 . . .
- **Log data:** Maximum of 20 sets
- **Maximum depth:** 100 m (300 ft) ("Over M" / "Over ft" is displayed when the maximum depth has been exceeded)
- **Minimum water temperature :** -9.9°C~+40°C (14°F to 104°F)
"--°C" ("--°F") is displayed when display range has been exceeded.
- **Dive time:** Displayed in minutes and seconds.
Displayed in minutes and seconds up to 99 minutes 59 seconds and displayed in 3 digits after that time.
Displayed as <--' --"> after 999 minutes have been exceeded.
- **Time zone/Daylight savings time:** The city name and daylight savings time ON/OFF status set in the time/date mode are displayed.
- **Dive starting time:** Time in time/date mode.
- **Dive date:** Month and date in time/date mode.
- **Function hand:** Moves to indication of maximum depth.

- **The log cannot be switched by pressing a button while the hands are moving.**
- The watch automatically returns to the time/date mode when none of the buttons are pressed for about 1 minute during display of log data.
- The watch automatically switches to the "Reference Position Correction Mode" if button (D) is pressed during display of log data.

B. Recalling Log Data

- (1) The most recent log data is displayed when the watch is switched to the diving log recall mode.
- (2) Select the log data by pressing button (A). (The display can be advanced rapidly by continuously depressing button (A)).
 - "LOG --" is displayed when there is no log data recorded.
 - The inspection log is displayed after the oldest log. The inspection log contains important data on the strict shipping inspection performed at the factory prior to shipment of the watch. This log data cannot be deleted even if log data is attempted to be deleted.
- (3) The watch switches to the log data display when button (C) is pressed.

[Log Sequence]

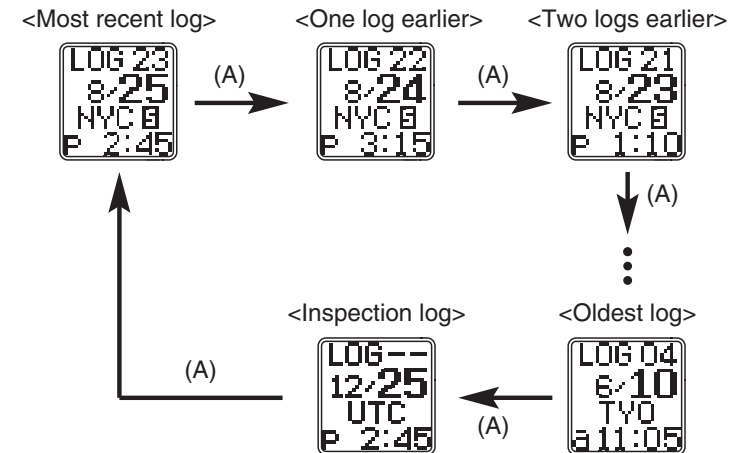

C. Log Number

- Log numbers are displayed using two digits, and are recorded from "01" to "99". After log number "99", logs are recorded as "00", "01", "02" and so on.
- After log data for log numbers "01" to "20" have been recorded and a new dive is made, the oldest log data of "01" is automatically deleted and log data is recorded by assigning a log number of "21" for the new dive.

D. Deleting Log Data

CAUTION

- **Record important log data in a log book before deleting. When log data is deleted, all log data is deleted with a single procedure.**

[Deletion Procedure]

- (1) Switch the watch to the diving log recall mode.
- (2) Press buttons (A) and (C) simultaneously for about 2 seconds or more.
 - **All log data except for the inspection log are deleted.**

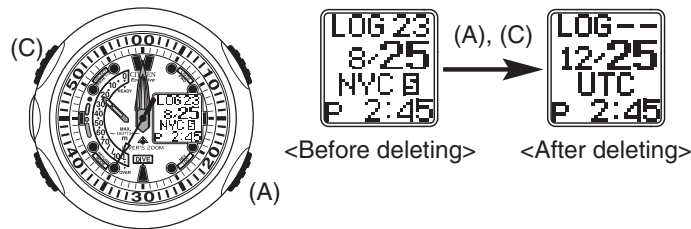

E. Regarding Log Data

CAUTION

- **When 20 sets of log data have been recorded, the oldest log is deleted automatically when a new dive is started. Promptly record important log data in a log book.**
- Data may be lost when the watch is repaired or inspection, and rarely as a result of the watch malfunctioning. It is recommended to promptly record log data in a log book after diving.
- **The inspection log will remain following deletion of log data.** The inspection log contains important data on inspections performed prior to shipping the watch. This log cannot be deleted by performing the log data deletion procedure.
- Please note that the manufacturer is not responsible for log data that should happen to be lost due to a malfunction.

Reference Position Check Mode

This mode is used to check that all of the watch hands, including the function hand, are at the correct positions to ensure that the watch functions properly.

- The hand reference position may shift if the watch has been subjected to strong impacts or the effects of magnetism and other environmental factors. If the watch is used with the hands shifted from their reference positions, the time display, diving mode and other operations of the watch will not function properly. If this happens, perform the "Reference Position Check" to correct the reference position of each hand.

A. Checking the Reference Position

- Switch the watch to the "Reference Position Check" mode.
 - The second, minute and hour hands move to the reference position (12:00:00).
 - The function hand moves to the "0" (READY) position on the depth scale.
- Correction is not required if each hand indicates the correct position. Press button (D) to return to the previously used mode.
 - If the hands are not at their reference positions, correct them to the correct positions by referring to the correction procedure described below.

[Reference Position of Each Hand and Digital Display]

- Second, minute and hour hands:** 12:00:00
- Function hand:** 0 position on depth scale
- Digital display:** RESET

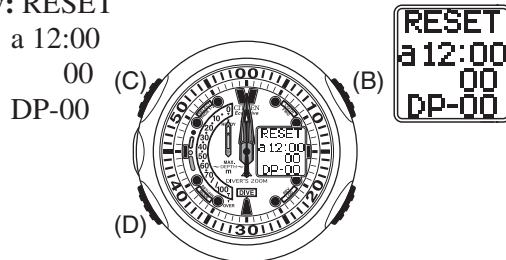

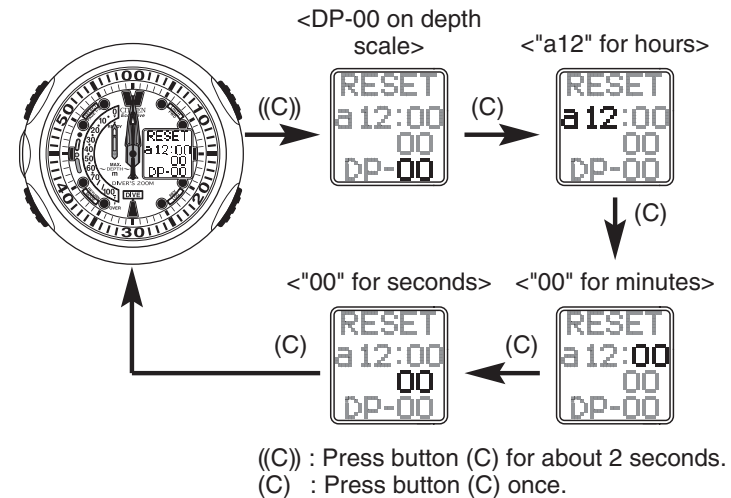

[Correcting Reference Position of Each Hand]

- Switch the watch to the "Reference Position Check" mode.
- Press button (C) for about 2 seconds or more.
 - "00" of "DP-00" flashes on the digital display.
 - The function hand moves when button (B) is pressed. Press button (B) several times until the function hands indicates "0" on the depth scale.
- Press button (C).
 - The corrected location changes in the order shown below each time button (C) is pressed.
 - Press button (B) to align each hand at 12:00.





- Once each hand has been aligned at its reference position, press button (D) to return the watch to the previously used mode.

Troubleshooting

Problem	Possible Cause	Corrective Action	Reference
Watch does not switch to diving mode	<ul style="list-style-type: none"> The insufficient charge alarm has been activated and the [ Charge : Insufficient Charge Alarm mark] is displayed as a result of the watch being insufficiently charged. (The watch does not switch to the diving mode if insufficiently charged.) Is an error mark such as the Water Sensor Detection Error mark [] displayed? 	<ul style="list-style-type: none"> Charge the watch to level 5 by exposing to light. Is the water sensor still wet? Check for the presence of stones or debris around the pressure sensor. 	<ul style="list-style-type: none"> Charge Level Indicator and Continuous Operating Times Dive Alarm Functions
Log data is not recorded during diving	<ul style="list-style-type: none"> The charge of the secondary battery has become low while diving. Is the Low Charge [] mark displayed? Has the number of log data reached the log capacity? 	<ul style="list-style-type: none"> Ascend at a safe ascent rate as soon as possible and charge the watch to level 5. Have the watch inspected at our service center. 	<ul style="list-style-type: none"> Dive Alarm Functions

Problem	Possible Cause	Corrective Action	Reference
Log data does not accurately reflect an actual dive	<ul style="list-style-type: none"> The watch has not switched to the diving mode for some reason during diving. Recording of log data is interrupted if the watch becomes insufficiently charged (level 0). 	<ul style="list-style-type: none"> Is the water sensor still wet? Check for the presence of stones or debris around the pressure sensor. Always make sure to sufficiently charge the watch to level 5 before diving. 	<ul style="list-style-type: none"> Dive Alarm Functions Charge Level Indicator and Continuous Operating Times
The [] mark does not disappear for a long period of time	<ul style="list-style-type: none"> The pressure sensor is continuing to operate due to sand, debris or perspiration adhering to the pressure sensor. 	<ul style="list-style-type: none"> Rinse off any debris around the pressure sensor with water and then completely wipe off any moisture with a dry cloth. 	<ul style="list-style-type: none"> Dive Alarm Functions
The watch does not leave the diving mode	<ul style="list-style-type: none"> The water sensor continues to operate and cannot be canceled as a result of water or perspiration remaining on the water sensor. 	<ul style="list-style-type: none"> Rinse off the area around the water sensor with water and then completely wipe off any moisture with a dry cloth. 	<ul style="list-style-type: none"> Dive Alarm Functions

Problem	Possible Cause	Corrective Action	Reference
Second hand moves at 2-second intervals	<ul style="list-style-type: none"> The charge of the secondary battery has become low and the insufficient charge alarm function has been activated [ : Insufficient Charge Alarm mark is displayed) as a result of the watch being insufficiently charged. 	<ul style="list-style-type: none"> Sufficiently charge the watch to level 5 by exposing to light. 	<ul style="list-style-type: none"> Charge Level Indicator and Continuing Operating Times
Alarm does not sound	<ul style="list-style-type: none"> The insufficient charge alarm function has been activated [ : Insufficient Charge Alarm mark is displayed) as a result of the watch being insufficiently charged. Is the alarm set to OFF? 	<ul style="list-style-type: none"> Sufficiently charge the watch to level 5 by exposing to light. Set the alarm to ON and check the time and city name. 	<ul style="list-style-type: none"> Charge Level Indicator and Continuing Operating Times Using the Standard Mode: 4. Using the Alarm Mode
EL light does not light	<ul style="list-style-type: none"> The insufficient charge alarm function has been activated [ : Insufficient Charge Alarm mark is displayed) as a result of the watch being insufficiently charged. The EL light does not light if the charge level is 0, 1 or 2. 	<ul style="list-style-type: none"> Sufficiently charge the watch to level 5 by exposing to light. 	<ul style="list-style-type: none"> Charge Level Indicator and Continuing Operating Times Using EL light

Problem	Possible Cause	Corrective Action	Reference
Mode does not switch	<ul style="list-style-type: none"> Is dirt or debris trapped between the watch body and button (D)? 	<ul style="list-style-type: none"> Have the watch inspected and repaired at a Citizen Service Center when dirt or debris has become trapped in button (D) preventing from being pressed. 	<ul style="list-style-type: none"> Using the Standard Mode Handling Precautions: Repairs
Abnormal watch display or operation (incorrect digital display, alarm sounds continuously, etc.)	<ul style="list-style-type: none"> The display or operation of the watch may rarely become abnormal if accidentally subjected to a strong impact or strong static electricity. 	<ul style="list-style-type: none"> Perform the all-reset procedure. If the problem is still not resolved, consult the Citizen Service Center. 	<ul style="list-style-type: none"> All-Reset Handling Precautions: Repairs
Letters and numbers on digital display change slowly	<ul style="list-style-type: none"> The display of letters and numbers may change slowly in environments at a low ambient temperature. 	<ul style="list-style-type: none"> The display returns to normal when the watch is returned to a normal temperature. 	<ul style="list-style-type: none"> Specifications: Watch Operating Temperature Range

Meanings of Frequently Displayed Mode Marks and Digital Display

[Mode Marks]



Daylight Savings Time:

This is displayed when daylight savings time has been set for a city displayed in the time/date mode or travel time mode.



Surface:

This is displayed when the surface mode is operating (measurement of elapsed time after diving).



Alarm Mode:

1 : Alarm 1 mode displayed.
 2 : Alarm 2 mode displayed
 3 : Alarm 3 mode displayed



Set Mark:

This is displayed when switching to the correction mode of the time/date mode.



Error Mark:

This is displayed in the time/date mode when a water sensor detection error, pressure sensor disconnection or 0 m (0 ft) detection error has occurred.



ON/OFF Mark:

ON or OFF is displayed when setting the alarm mode or when setting the water depth and alarm time in the dive alarm setting mode.



Display Number:

A 1 or 2 is displayed for display 1 and display 2 in the surface mode and during depth measurement.



Diver Mark:

This is displayed on display 1 during depth measurement in the diving mode.



Dive Alarm Setting Mode:

This is displayed together with the set alarm depth and dive time when the watch is switched to the dive alarm setting mode.



Alarm Depth Correction Mark:

This is displayed when correcting the alarm depth in the dive alarm setting mode.



Dive Time Correction Mark:

This is displayed when correcting the alarm time in the dive alarm setting mode.



Ascent Rate Alarm:

This is displayed when the ascent rate exceeds the ascent alarm rate during depth measurement.



Level 0 Mark:

This is displayed when the charge level of the secondary battery has reached level 0.



Level 1 Mark:

This is displayed instead of the diver mark when the charge level of the secondary battery has reached level 1 during depth measurement.

[Digital Display]



- Displays city name, daylight savings time setting, month date and day when in the time/date mode.



- Displays city name, daylight savings time setting, month, date and day in the time/date mode, and indicates that surface measurement is in progress.



- Indicates that a water sensor detection error has occurred in the time/date mode.



- Indicates that the watch has entered the correction mode of the time/date mode. The number next to SET and the flashing location change when the corrected location is changed.

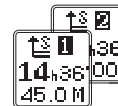

- Displays the elapsed time after diving and the maximum depth, dive time and other information during diving while the surface mode is operating.



- Displays the city name, daylight savings time setting, month, date and day when in the travel time mode.



- Displays the city name for which the alarm is set, the set time and the daylight savings time setting when in the alarm 1, 2 or 3 mode.



- Displays the set alarm depth and dive time when in the dive alarm setting mode.



- Sets the alarm depth in the dive alarm setting mode.



- Sets the alarm time (dive time) in the dive alarm setting mode.



- Displays the maximum depth, minimum water temperature and dive time corresponding to the log number when in the diving log recall mode.



- The inspection log is displayed last after recalling log numbers when in the diving log recall mode.



- Alternately displays READY and ready after the watch is automatically switched to the diving mode (Diving Ready 1) when the water sensor detects water.



- Displays READY and the current time when the watch switches from Diving Ready 1 to Diving Ready 2.



- The diver mark appears and the current time and current depth are displayed on display 1, and the dive time and maximum depth are displayed on display 2 when the watch begins measuring depth from Diving Ready 1 or Diving Ready 2.



- A dive alarm sounds, the LED flashes and SLOW is displayed on the digital display when the ascent alarm rate has been exceeded during depth measurement.



- The abnormal depth mark is displayed after judging the depth to be incorrect when the measured depth has exceeded the depth measured one second earlier by ± 4.0 m (± 13 ft).



- The battery mark and Charge are displayed when the capacity of the secondary battery has decreased and a charge level 0 has been detected. The same display appears during depth measurement when a charge level 0 has been detected.



- The battery mark and Charge are displayed when the capacity of the secondary battery has decreased and a charge level 1 has been detected during depth measurement.



- ALL-RESET is displayed after the entire display has been cleared by pressing all four buttons simultaneously.



- The reference positions (hours, minutes, seconds and depth) are displayed when the watch is switched to the reference position check mode.



- A "LOG** . ERROR" is displayed when the number of log data approaches the predetermined log capacity.

|| All-Reset

The all-reset procedure returns all watch settings, including the time and date, to their default settings.

However, log data remains stored in memory without being lost.

Perform the all-reset procedure when the watch does not display information or operate properly.

[Procedure]

(1) Press and release all four buttons (A), (B), (C) and (D) simultaneously.

• The following occur when this is done.

- ① The alarm tone sounds.
- ② The digital display is refreshed and "ALL RESET" is displayed.
- ③ The second, minute and hour hands each make one revolution in that order.
- ④ The function hand moves to the "0" position.
- ⑤ The EL light lights.
- ⑥ The LED lights.
- ⑦ The alarm tone sounds.
- ⑧ The digital display changes to the "RESET" display as shown in the illustration.

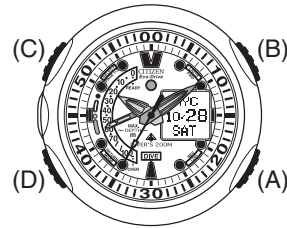

(2) Align each hand at the reference position.

- ① Press button (C) for about 2 seconds.
 - "00" flashes at "DP-00" on the digital display.
 - The function hand moves when button (B) is pressed. Press button (B) several times until the function hand indicates "0" (READY) on the depth scale.
- ② Press button (C).
 - "a12" flashes for hours on the digital display.
 - Press button (B) to align the hour hand at 12:00.
 - Continuously depressing button (B) causes the hour hand to move continuously.
- ③ Press button (C).
 - "00" is displayed for minutes on the digital display.
 - Press button (B) to align the minute hand at 12:00.
 - Continuously depressing button (B) causes the minute hand to move continuously.
- ④ Press button (C).
 - "00" is displayed for seconds on the digital display.
 - Press button (B) to align the second hand at 12:00.
 - Continuously depressing button (B) causes the second hand to move continuously.
- ⑤ Press button (C).
 - This completes the procedure for aligning each hand at the reference position.

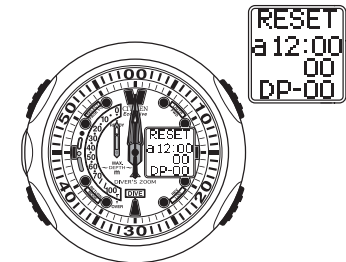

Properly reset each mode, including the time and date, before using the watch.

Using EL light

- The EL light is illuminated for about 2 seconds by pressing button (B).

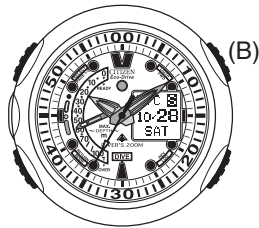

<The EL light does not light in the following cases.>

- When the charge level is low at level 0 to 2.
If button (B) is pressed while the watch charge level is 2 an alarm sounds indicating that the EL light will not light.
- While switching to a different mode and when making corrections in each mode.
- When the watch is at a low temperature (generally 0°C (32°F) or below).
- The EL light cannot be illuminated for about 2 seconds after it goes out even if button (B) is pressed.

Models Provided with an Extension Band

- * Some models are not provided with an extension band.
- When wearing the watch over a wetsuit and so forth, and the length of the standard band is not long enough, attach the extension band provided to adjust the length of the band.

<Extension band>

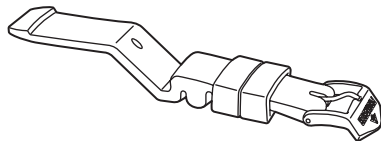

[Attaching the Extension Band]

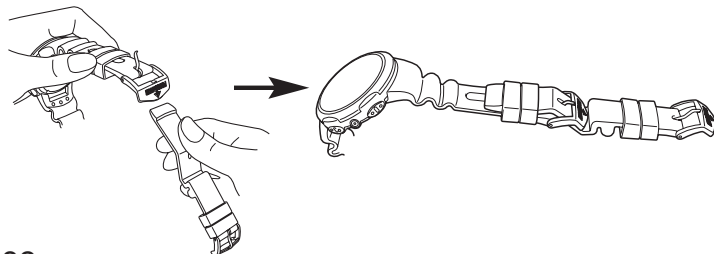





Handling Precautions (for the watch)



WARNING

Water Resistance Performance

This watch is water resistant to 200 meters. Although it can be used for air diving using an air tank (scuba diving), it cannot be used for saturation diving involving the use of helium gas.

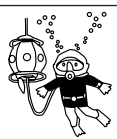
		Indication
		Case (case back)
Examples of Use		AIR DIVER'S 200m
	Minor exposure to water (washing face, rain, etc.)	OK
	Moderate exposure to water (washing, kitchen work, swimming, etc.)	OK
	Skin diving, marine sports	OK
	Scuba diving using an air tank	OK
	Saturation diving using helium gas	NO

WARNING

- The rubber gaskets and other seals used in this watch will deteriorate over time and use. If the gaskets and seals are not checked at regular intervals, their condition may not be sufficient to guard against the entrance of moisture. In order to maintain the water resistant quality of your watch, we recommend you have the gaskets and seals of your watch inspected by a CITIZEN Authorized Service Center every two to three years. More frequent inspections may be necessary if the watch is used in environments such as chlorinated pools or if the watch is not rinsed with clear water after use in salt water. Gaskets and seals used to guard against the entrance of moisture are considered consumable supplies that are not covered under the terms of the warranty. Inspections and any components that need to be replaced in order to maintain the water resistant quality of the timepiece are at the expense of the consumer.
- If moisture has entered the watch, or if the inside of the glass is fogged up and does not become clear for an extended period of time, do not leave the watch in that state, but immediately take the watch to a Citizen Service Center for inspection and repair.
- If sea water enters the watch, place the watch in a box or plastic bag, and immediately take it in for repair. Otherwise, pressure inside the watch will increase and parts (such as the glass and buttons) may come off.

WARNING **Handling of Energy Storage Cell**

- Do not attempt to remove the energy storage cell from the watch. If the energy storage cell must be unavoidably removed, place it in a location out of the reach of children to prevent accidental swallowing.
- If the energy storage cell is accidentally swallowed, contact a physician immediately and seek medical attention.

WARNING **Only Use Specified Energy Storage Cell**

- Never attempt to use an energy storage cell other than the energy storage cell used by this watch. Although the structure of the watch prevents the watch from operating if another battery is installed, if a silver battery or other type of battery is forcibly installed in the watch and the watch is attempted to be charged with that battery installed, the battery may rupture resulting in possible damage to the watch and physical injury. Always make sure to use the specified energy storage cell when replacing.

WARNING **Repairs**

All parts of this watch, excluding the band, are to be repaired only at a Citizen Service Center. Please have all inspections and repairs performed at a Citizen Service Center.

CAUTION **Keep your watch clean**

- The case and band of the watch come in direct contact with the skin in the same manner as clothing. Metal corrosion as well as perspiration, dirt, dust and other unnoticed debris may soil the cuffs and other parts of your clothing. Try to keep the watch clean at all times.
- Wearing of this watch may cause a rash or itching of the skin in people with sensitive skin or depending on the wearer's physical condition. If you notice that your skin is affected by the watch, immediately stop wearing it and consult a physician.

<Cleaning the Watch>

- Use a soft cloth to wipe off dirt, perspiration and moisture from the case and crystal.
- Rinse off dirt from metal bands, plastic bands or rubber bands with water. Use a soft brush to remove any dirt or debris stuck between the gaps in metal bands.
- Avoid the use of solvents (such as thinner or benzene) as they may damage the finish.



CAUTION

Precautions When Wearing the Watch

- Be careful while wearing the watch while holding an infant or child, by taking the watch off beforehand, to prevent injury or other accident.
- Be careful when engaged in vigorous exercise or work to prevent injury and accidents to yourself and others.
- Never wear the watch in a sauna or other locations where the watch can reach high temperatures since this can cause burns.



CAUTION

Handling of the Band (Cautions when Putting on and Taking Off the Watch)

Depending on the structure of the band buckle, be careful not to injure your fingernails when putting on and taking off the watch.

<Temperatures>

The watch may not function or stop running if exposed to temperatures outside the range of 0°C to 55°C (32°F to 131°F). In addition, although the liquid crystal display may also become illegible outside this temperature range, it will return to normal when the watch is returned to normal temperatures.

<Static Electricity>

Since the IC used in quartz watches is susceptible to static electricity, the display may become incorrect if the watch is subjected to intense static electricity like that generated by a television screen.

<Shocks>

Do not subject the watch to violent shocks such as that resulting from being dropped on the floor.

<Chemical Agents, Gases and Mercury>

Avoid using the watch in environments containing chemical agents and gases. If solvents such as thinner or benzene, as well as articles containing such substances (including gasoline, fingernail polish, cresol, bathroom cleaners and adhesives) become adhered to the watch, they can cause discoloration, deterioration and cracking. Use ample caution when handling chemicals. In addition, contact with mercury used in thermometers and so forth can cause the case and band to become discolored.

<Storage>

- When not using the watch for an extended period of time, carefully wipe off any perspiration, dirt or moisture from the watch and store in a location preferably free of high and low temperatures, high humidity.
- When not using your watch for an extended period of time, it is recommended to store it in a location that is exposed to light as much as possible.

Specifications

- **Model:** U10*
- **Crystal oscillation frequency:** 32,768 Hz
- **Watch operating temperature range:** 0°C to +55°C (32°F to 131°F)
- **Timekeeping accuracy:** ±15 seconds per month on average (when wearing at normal temperatures of +5°C to +35°C/41°F to 95°F)
- **Depth measurement accuracy:**
 - 0 m to 100 m: Within ±(1% of displayed value + 0.3 m) (when used at a constant temperature)
 - 0 ft to 300 ft: Within ±(1% of displayed value + 1 ft) (when used at a constant temperature)
 - Guaranteed accuracy temperature range: 0°C to +40°C (water depth range: 0 m to 100 m) 32°F to 104°F (water depth range: 0 ft to 300 ft)
 - * The accuracy of water depth measurement is affected by changes in ambient temperature.
 - Working altitude range: 300 m to 3,000 m/1,000 ft to 10,000 ft (above sea level)
- **Water depth measurement range:** 1.0 m to 100.0 m/ 0 ft to 300 ft
- **Water temperature measurement accuracy:** Displayed value ± 2°C/± 4°F
- **Water temperature measurement range:** -9.9°C to +40°C/14°F to 104°F
- **Modes and Display Functions:**
 - ◆ **Standard Mode**
 - **Time:**
Analog: Hour hand, minute hand, second hand, function hand (charge level/ depth measurement)
Digital: City name, month, date, day, year (during correction only), daylight savings time
 - **Surface time measurement (measurement and display of time on surface following completion of a valid dive):** Hours, minutes (up to 24 hours), previous dive time, previous maximum depth

- **Travel Time:**
Analog: Time in the time/date mode
Digital: City name, hours, minutes month, date, daylight savings time
- **Alarm 1:**
Analog: Alarm time (hours, minutes)
Digital: City name, hours, minutes, ON/OFF setting, daylight savings time
Alarm monitor
- **Alarm 2:**
Analog: Alarm time (hours, minutes)
Digital: City name, hours, minutes, ON/OFF setting, daylight savings time
Alarm monitor
- **Alarm 3:**
Analog: Alarm time (hours, minutes)
Digital: City name, hours, minutes, ON/OFF setting, daylight savings time
Alarm monitor
- **Diving Mode:**
 - Dive alarm setting:
 - Depth alarm (dive alarm tone sounds, LED lights)
Setting range: 5 m to 99 m/5 ft to 295 ft
Setting units: 1 m/5 ft
ON/OFF switching
 - Dive time alarm (dive alarm tone sounds, LED lights)
Setting range: 5 to 99 minutes
Setting units: 1 minute
ON/OFF switching
- **Diving log recall:**
 - No. of diving logs capable of being recalled:
Most recent 20 logs
 - Log contents: Log number (01-99, 00), dive date, time zone, daylight savings time, dive starting time, maximum depth, minimum water temperature, dive time

◆ **Water sensor**

◆ **Pressure sensor**

◆ **Alarm functions**

Digital display error

Water sensor error

Pressure sensor error

Measurement error (0 m/0 ft detection)

Diving log memory error

Abnormal depth alarm

Depth measurement out of range error

Ascent rate alarm

Abnormal depth display

Dive time alarm

◆ **Additional Functions**

- Charge level indicator function
- Insufficient charge warning function
- Power save 1
- Power save 2
- Overcharge prevention function
- EL light

○ **Continuous operating times:**

- From fully charged to stopped without recharging:
Approx. 6 months (when Power Save is not activated)
Approx. 2.5 years (when Power Save 2 is activated)
 - From 2-second interval movement to stopped: Approx. 2 days.
- * Continuous operating times may vary according to the frequency at which the watch is used for diving, alarm operation and other factors.

○ **Battery:** Secondary battery, 1

* Specifications are subject to change without notice.

The manufacturer is not responsible for damages, revenue losses or any claims from a third party incurred due to use of this manual or products described in this manual.